

STOP LIGHTS

STOP / TURN /TAIL

Pages 13-43

LED

SERIES	COMMON SIZE	PAGES
44® Series	4"	13
Super 44®	4"	14-20
45® Series	3" x 5"	20-21
60® Series	2" x 6"	22-25
Super 66	2" x 6"	25-26
Signal-Stat Round	4"	27
Signal-Stat Oval	2" x 6"	28
Signal-Stat Rectangular	3" x 5"	29

INCANDESCENT

SERIES	COMMON SIZE	PAGES
40® Series	4"	30-32
40® Economy	4"	33-34
Super 40®	4"	35-36
41 Series	3" x 5"	37
Super 45®	3" x 5"	37-38
60® Series	2" x 6"	38
60® Economy	2" x 6"	38-39
Super 60®	2" x 6"	39
80 Series	4"	40
90 Series	7"	41
91® Series	7"	42
4 Screw	4" x 6"	43

HIGH-MOUNTED STOP LIGHTS

Pages 44-47

LED

SERIES	COMMON SIZE	PAGES
21® Series	2" x 6"	44
60® Series	2" x 6"	44-45
Adhesive Mount	1" x 9"	45

INCANDESCENT

SERIES	COMMON SIZE	PAGES
40® Series	4"	46
45® Series	3" x 5"	46
60® Series	2" x 6"	46-47
Super 60®	2" x 6"	47

COMBINATION BOX LIGHTS

Pages 48-52

LED

SERIES	PAGES
2 Stud Mount	48
3 Stud Mount	48

INCANDESCENT

SERIES	PAGES
Ford	49
Ford/Dodge	49
Freightliner	49
Freightliner/Peterbilt/ GM	49
Freightliner/Peterbilt/GM/Oshkosh	50
Navistar	50
Volvo	51
2 Stud Mount	52
3 Stud Mount	52







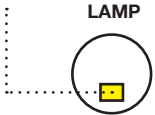
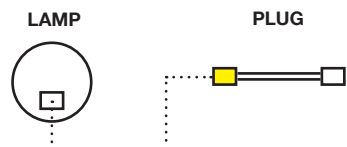
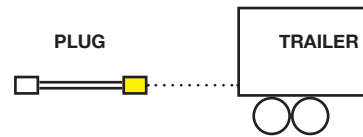





Stop Lights

Whether your vehicle calls for a classic stop/turn/tail lamp or a combination box lamp, Truck-Lite has the right size, shape, material, mount and connection type for any application.

<p>Shapes</p>	<p>Round, Oval, Rectangular, Square</p>
<p>Mount Types</p>	<p>Grommet, Flange, 2 Screw, 4 Screw</p>
<p>Connection Information</p> <p>When it comes to choosing the correct lamps for your truck or trailer, it's important to know the connection type on your vehicle's harness.</p> <p>If the harness connector type does not match your desired light (lamp connector), you will need a plug to complete the connection.</p>	<p>Lamp Connector</p> <p>The connector type located on the back of a lamp</p>  <p>Plug Side 1</p> <p>The connection between a plug and a lamp</p>  <p>Plug Side 2</p> <p>The connection between a plug and a trailer's harness</p> 

(800) 562-5012 | truck-lite.com

 <p>Manufacturing & Quality</p>	 <p>Testing & Safety</p>
<p>Truck-Lite's LED stop/turn/tail lighting is built using premium materials and backed by industry-leading warranties.</p> <p>Designed to last the life of your vehicle, Truck-Lite's solid-state construction and sealed circuitry mean that you can depend on your lighting to withstand shock, vibration, moisture and debris.</p>	<p>All Truck-Lite lamps are subjected to rigorous environmental, electrical and mechanical testing before they are validated and released to the market.</p> <p>All lamps comply with FMVSS/CMVSS-108, SAE and DOT standards when properly mounted.</p>
 <p>Performance & Maintenance</p>	 <p>Customer Support</p>
<ul style="list-style-type: none"> • Lower energy consumption • Impact-resistant, non-yellowing lenses and rugged housing protect against damage from even the toughest applications • Robust, cost-effective design 	<p>Customer Service  (800) 562-5012 customerservice@truck-lite.com</p> <p>Technical Support  (888) 562-5012 tltech@truck-lite.com</p> <p>S/T/T Light Warranties</p> <div style="display: flex; justify-content: space-around;">     </div>
<p style="text-align: center;">(800) 562-5012 truck-lite.com</p>	

Looking for even more product information?

Visit truck-lite.com



Powerful Search



360° Product Images



Easy-To-Find Replacement Parts

44[®] SERIES, LED, 1 DIODE, 4" ROUND, GROMMET MOUNT, HARDWIRED



- Electronics completely sealed in epoxy to resist moisture & corrosion
- Lamp hardwired - wire leads incorporate .180 jacketed bullet terminals
- Sealed polycarbonate lens & housing
- Voltage 10V to 30V

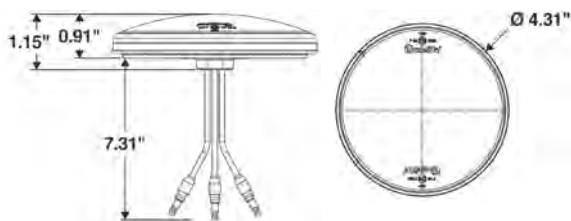

Part Number	Lamp Connector	Plug Side 1	Plug Side 2	Lens Material	Volts	Amps Major/Minor
44932R	Hardwired	Hardwired	.180 Bullet	PC	12 24	0.23 / 0.02

44[®] SERIES, LED, 1 DIODE, 4" ROUND, GROMMET MOUNT, HARDWIRED, KIT



- Electronics completely sealed in epoxy to resist moisture & corrosion
- Lamp hardwired - wire leads incorporate .180 jacketed bullet terminals
- Sealed polycarbonate lens & housing
- Voltage 10V to 30V

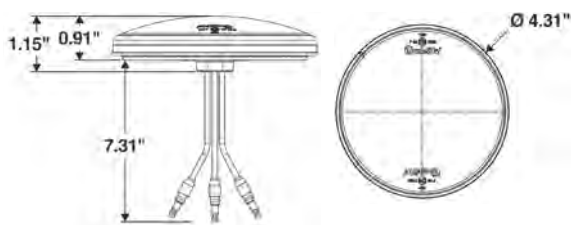

Part Number	Lamp Connector	Plug Side 1	Plug Side 2	Lens Material	Mount Color	Volts	Amps Major/Minor	Kit Includes/ Replacement Parts
44121R	Hardwired	Hardwired	.180 Bullet	PC	Black	12 24	0.23 / 0.02	44932R lamp, 40700 grommet

44[®] SERIES, LED, 1 DIODE, 4" ROUND, FLANGE MOUNT, HARDWIRED



- Electronics completely sealed in epoxy to resist moisture & corrosion
- Lamp hardwired - wire leads incorporate .180 jacketed bullet terminals
- Sealed polycarbonate lens & housing
- Voltage 10V to 30V

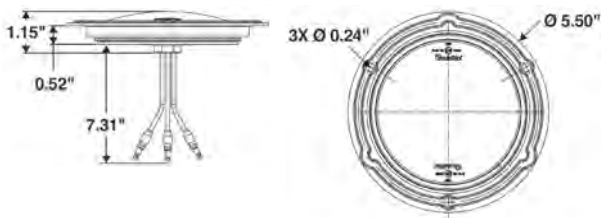

Part Number	Lamp Connector	Plug Side 1	Plug Side 2	Lens Material	Mount Color	Volts	Amps Major / Minor
44936R	Hardwired	Hardwired	.180 Bullet	PC	Black	12 24	0.23 / 0.02

SUPER 44®, LED, 6 DIODES, 4" ROUND, GROMMET MOUNT

LED

SUPER 44



- Faster illumination offers significant safety benefit for following drivers to react more quickly, resulting in an average distance of 3' reaction time advantage for every 10 mph
- LEDs have no filament, therefore are extremely resistant to shock & vibration
- Less current draw, resulting in increased battery & alternator life while allowing more power for other vehicle requirements



Part Number	Lamp Connector	Lens Material	Volts	Amps Major/Minor	Diamond Shell
44302R	Fit 'N Forget S.S.	PC	12	0.24 / 0.03	No
44982R	Fit 'N Forget S.S.	AC	12	0.24 / 0.03	Yes

SUPER 44®, LED, 6 DIODES, 4" ROUND, GROMMET MOUNT, KIT

LED

SUPER 44



- Faster illumination offers significant safety benefit for following drivers to react more quickly, resulting in an average distance of 3' reaction time advantage for every 10 mph
- LEDs have no filament, therefore are extremely resistant to shock & vibration
- Less current draw, resulting in increased battery & alternator life while allowing more power for other vehicle requirements Light includes 94706 Stop/Turn/Tail adapter plug



Part Number	Lamp Connector	Plug Side 1	Plug Side 2	Lens Material	Mount Color	Volts	Amps Major/Minor	Diamond Shell	Kit Includes/ Replacement Parts
44030R	Fit 'N Forget S.S.	Fit 'N Forget S.S.	Straight Female PL-3	PC	Black	12	0.24 / 0.03	No	4700 grommet, 94706 plug
44092R	Fit 'N Forget S.S.	Fit 'N Forget S.S.	Straight Female PL-3	AC	Black	12	0.24 / 0.03	Yes	4700 grommet, 94706 plug

Keep Your Connections Safe. Don't Forget Your Dielectric Gel.

Dielectric gel protects your lights by protecting the points of contact between elements of your lighting and harness system. Our dielectric compounds prevent arcing and corrosion and keep your lights performing as they should.

You can find our dielectric products on page 498



SUPER 44[®], LED, 6 DIODES, 4" ROUND, GROMMET MOUNT, HARDWIRED



- Faster illumination offers significant safety benefit for following drivers to react more quickly, resulting in an average distance of 3' reaction time advantage for every 10 mph
- design results in decreased depth compared to integral plug versions, allowing for mounting in confined spaces
- LEDs have no filament, therefore are extremely resistant to shock & vibration, a major cause of failure for lamps with incandescent bulbs
- Less current draw, resulting in increased battery & alternator life while allowing more power for other vehicle requirements



Part Number	Lamp Connector	Plug Side 1	Plug Side 2	Lens Material	Volts	Amps Major/Minor	Diamond Shell
44350R	Hardwired	Hardwired	Stripped End	PC	12	0.24 / 0.03	No
44351R	Hardwired	Hardwired	Straight Female PL-3	PC	12	0.24 / 0.03	No
44353R	Hardwired	Hardwired	Fit 'N Forget S.S.	PC	12	0.24 / 0.03	No
44354R	Hardwired	Hardwired	Packard Connector	PC	12	0.24 / 0.03	No
44355R	Hardwired	Hardwired	Male Pin	PC	12	0.24 / 0.03	No
44959R	Hardwired	Hardwired	Stripped End	PC	12	0.24 / 0.03	Yes
44960R	Hardwired	Hardwired	Straight Female PL-3	PC	12	0.24 / 0.03	Yes
44972R	Hardwired	Hardwired	Fit 'N Forget S.S.	PC	12	0.24 / 0.03	Yes
44973R	Hardwired	Hardwired	Packard Connector	PC	12	0.24 / 0.03	Yes
44974R	Hardwired	Hardwired	Male Pin	PC	12	0.24 / 0.03	Yes

Stop/Turn/Tail

**Need some back-up?
Super 44[®] Combo Lights
now available.**

Receive the same safety and low-maintenance benefits of existing LED stop/turn/tail and back-up lights— now in one package.

You can find our Super 44[®] combo lights on page 18



Back-Up

SUPER 44[®], LED, 6 DIODES, 4" ROUND, FLANGE MOUNT

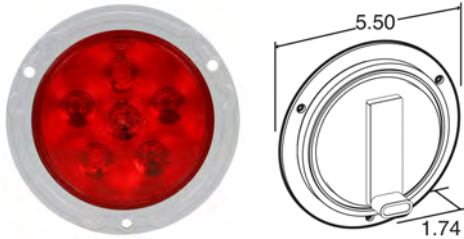

- Faster illumination offers significant safety benefit for following drivers to react more quickly, resulting in an average distance of 3' reaction time advantage for every 10 mph
- Flange mounts are permanently affixed to lamp
- LEDs have no filament, therefore are extremely resistant to shock & vibration
- Less current draw, resulting in increased battery & alternator life while allowing more power for other vehicle requirements



Part Number	Lamp Connector	Lens Material	Mount Color	Volts	Amps Major / Minor	Diamond Shell
44322R	Fit 'N Forget S.S.	PC	Gray	12	0.24 / 0.03	No
44326R	Fit 'N Forget S.S.	PC	Black	12	0.24 / 0.03	No
44328R	Fit 'N Forget S.S.	PC	White	12	0.24 / 0.03	No
44334R	Fit 'N Forget S.S.	PC	Silver	12	0.24 / 0.03	No
44983R	Fit 'N Forget S.S.	AC	Gray	12	0.24 / 0.03	Yes
44986R	Fit 'N Forget S.S.	AC	Black	12	0.24 / 0.03	Yes
44988R	Fit 'N Forget S.S.	AC	White	12	0.24 / 0.03	Yes

SUPER 44[®], LED, 6 DIODES, 4" ROUND, FLANGE MOUNT, KIT



- Faster illumination offers significant safety benefit for following drivers to react more quickly, resulting in an average distance of 3' reaction time advantage for every 10 mph
- Flange mounts are permanently affixed to lamp
- LEDs have no filament, therefore are extremely resistant to shock & vibration
- Less current draw, resulting in increased battery & alternator life while allowing more power for other vehicle requirements



Part Number	Lamp Connector	Plug Side 1	Plug Side 2	Lens Material	Mount Color	Volts	Amps Major/Minor	Diamond Shell	Kit Includes/ Replacement Parts
44032R	Fit 'N Forget S.S.	Fit 'N Forget S.S.	Straight Female PL-3	PC	Gray	12	0.24 / 0.03	No	94706 plug
44034R	Fit 'N Forget S.S.	Fit 'N Forget S.S.	Straight Female PL-3	PC	Silver	12	0.24 / 0.03	No	94706 plug
44036R	Fit 'N Forget S.S.	Fit 'N Forget S.S.	Straight Female PL-3	PC	Black	12	0.24 / 0.03	No	94706 plug
44038R	Fit 'N Forget S.S.	Fit 'N Forget S.S.	Straight Female PL-3	PC	White	12	0.24 / 0.03	No	94706 plug

SUPER 44[®], LED, 6 DIODES, 4" ROUND, FLANGE MOUNT, HARDWIRED



- Faster illumination offers significant safety benefit for following drivers to react more quickly, resulting in an average distance of 3' reaction time advantage for every 10 mph
- Hardwired design results in decreased depth compared to integral plug versions, allowing for mounting in confined spaces
- LEDs have no filament, therefore are extremely resistant to shock & vibration, a major cause of failure for lamps with incandescent bulbs
- Less current draw, resulting in increased battery & alternator life while allowing more power for other vehicle requirements



Part Number	Lamp Connector	Plug Side 1	Plug Side 2	Lens Material	Mount Color	Volts	Amps Major/Minor	Diamond Shell
44356R	Hardwired	Hardwired	Stripped End	PC	White	12	0.24 / 0.03	No
44357R	Hardwired	Hardwired	Straight Female PL-3	PC	White	12	0.24 / 0.03	No
44360R	Hardwired	Hardwired	Packard Connector	PC	White	12	0.24 / 0.03	No
44361R	Hardwired	Hardwired	Male Pin	PC	White	12	0.24 / 0.03	No
44362R	Hardwired	Hardwired	Stripped End	PC	Gray	12	0.24 / 0.03	No
44363R	Hardwired	Hardwired	Straight Female PL-3	PC	Gray	12	0.24 / 0.03	No
44365R	Hardwired	Hardwired	Fit 'N Forget S.S.	PC	Gray	12	0.24 / 0.03	No
44366R	Hardwired	Hardwired	Packard Connector	PC	Gray	12	0.24 / 0.03	No
44367R	Hardwired	Hardwired	Male Pin	PC	Gray	12	0.24 / 0.03	No
44953R	Hardwired	Hardwired	Stripped End	AC	Gray	12	0.24 / 0.03	Yes
44954R	Hardwired	Hardwired	Straight Female PL-3	AC	Gray	12	0.24 / 0.03	Yes
44956R	Hardwired	Hardwired	Fit 'N Forget S.S.	AC	Gray	12	0.24 / 0.03	Yes
44975R	Hardwired	Hardwired	Stripped End	AC	White	12	0.24 / 0.03	Yes
44980R	Hardwired	Hardwired	Male Pin	AC	White	12	0.24 / 0.03	Yes

Keep Your Connections Safe. Don't Forget Your Dielectric Gel.

Dielectric gel protects your lights by protecting the points of contact between elements of your lighting and harness system. Our dielectric compounds prevent arcing and corrosion and keep your lights performing as they should.

You can find our dielectric products on page 498



SUPER 44[®], LED, 8 DIODES, 4" ROUND, GROMMET MOUNT, S/T/T + BACK-UP COMBO, HARDWIRED

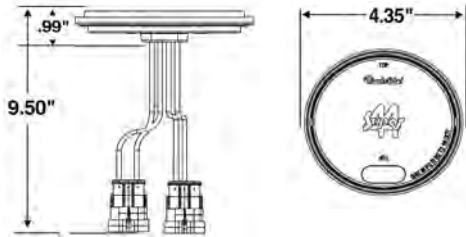

- Offers the same safety and low-maintenance benefits of existing LED S/T/T and BU lights now in one package
- Complies with FMVSS requirement for minimum of 75 cm² of luminous red area
- Saves space in inventory when stocking a two-in-one product
- New combination lamps are the same size as existing Truck-Lite Model 44 lights, so they fit into existing mounting holes
- Lower-cost system when replacing other hardwired 44 products



Part Number	Lamp Connector	Plug Side 1	Plug Side 2	Lens Material	Lens Color	Volts	Amps Major/Minor	Diamond Shell
44353R	Hardwired	Hardwired	Fit 'N Forget S.S.	PC	Red Clear	12	0.24 / 0.03	No

SUPER 44[®], LED, 8 DIODES, 4" ROUND, FLANGE MOUNT, S/T/T + BACK-UP COMBO, HARDWIRED

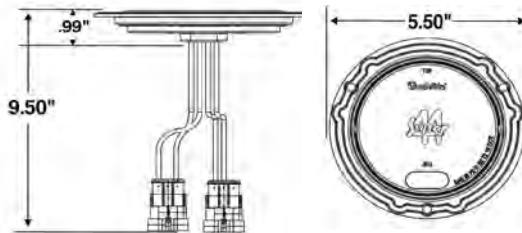

- Offers the same safety and low-maintenance benefits of existing LED S/T/T and BU lights now in one package
- Complies with FMVSS requirement for minimum of 75 cm² of luminous red area
- Saves space in inventory when stocking a two-in-one product
- New combination lamps are the same size as existing Truck-Lite Model 44 lights, so they fit into existing mounting holes
- Lower-cost system when replacing other hardwired 44 products



Part Number	Lamp Connector	Plug Side 1	Plug Side 2	Lens Material	Lens Color	Mount Color	Volts	Amps Major/Minor	Diamond Shell
44550R	Hardwired	Hardwired	Fit 'N Forget S.S.	PC	Red Clear	Black	12	0.24 / 0.03	No
44551R	Hardwired	Hardwired	Fit 'N Forget S.S.	PC	Red Clear	Gray	12	0.24 / 0.03	No

SUPER 44[®], LED, 17 DIODES, 4" ROUND, GROMMET MOUNT



- Faster illumination offers significant safety benefit for following drivers to react more quickly, resulting in an average distance of 3' reaction time advantage for every 10 mph
- LEDs have no filament, therefore are extremely resistant to shock & vibration
- Less current draw, resulting in increased battery & alternator life while allowing more power for other vehicle requirements

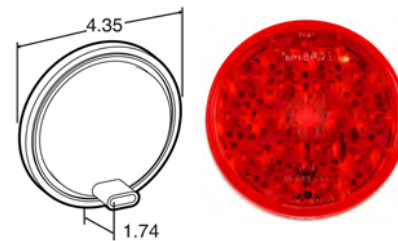

Part Number	Lamp Connector	Lens Material	Volts	Amps Major/Minor	Diamond Shell
44253R	Fit 'N Forget S.S.	PC	24	0.13 / 0.04	No

SUPER 44[®], LED, 17 DIODES, 4" ROUND, FLANGE MOUNT



- Faster illumination offers significant safety benefit for following drivers to react more quickly, resulting in an average distance of 3' reaction time advantage for every 10 mph
- Flange mounts are permanently affixed to lamp
- LEDs have no filament, therefore are extremely resistant to shock & vibration
- Less current draw, resulting in increased battery & alternator life while allowing more power for other vehicle requirements

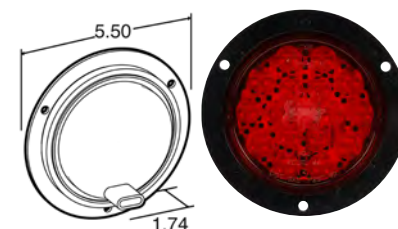

Part Number	Lamp Connector	Lens Material	Mount Color	Volts	Amps Major / Minor	Diamond Shell
44266R	Fit 'N Forget S.S.	PC	Black	24	0.13 / 0.04	No

SUPER 44[®], LED, 42 DIODES, 4" ROUND, GROMMET MOUNT



- Faster illumination offers significant safety benefit for following drivers to react more quickly, resulting in an average distance of 3' reaction time advantage for every 10 mph
- LEDs have no filament, therefore are extremely resistant to shock & vibration
- Less current draw, resulting in increased battery & alternator life while allowing more power for other vehicle requirements



Part Number	Lamp Connector	Lens Material	Volts	Amps Major/Minor	Diamond Shell
44202R	Fit 'N Forget S.S.	PC	12	0.5 / 0.1	No
44882R	Fit 'N Forget S.S.	AC	12	0.5 / 0.1	Yes

SUPER 44[®], LED, 42 DIODES, 4" ROUND, GROMMET MOUNT, KIT



- Faster illumination offers significant safety benefit for following drivers to react more quickly, resulting in an average distance of 3' reaction time advantage for every 10 mph
- Flange mounts are permanently affixed to lamp
- LEDs have no filament, therefore are extremely resistant to shock & vibration
- Less current draw, resulting in increased battery & alternator life while allowing more power for other vehicle requirements



Part Number	Lamp Connector	Plug Side 1	Plug Side 2	Lens Material	Mount Color	Volts	Amps Major/Minor	Diamond Shell	Kit Includes/ Replacement Parts
44002R	Fit 'N Forget S.S.	Fit 'N Forget S.S.	Straight Female PL-3	PC	Black	12	0.5 / 0.1	No	4700 grommet, 94706 plug
44082R	Fit 'N Forget S.S.	Fit 'N Forget S.S.	Straight Female PL-3	AC	Black	12	0.5 / 0.1	Yes	4700 grommet, 94706 plug

SUPER 44[®], LED, 42 DIODES, 4" ROUND, FLANGE MOUNT



- Faster illumination offers significant safety benefit for following drivers to react more quickly, resulting in an average distance of 3' reaction time advantage for every 10 mph
- Flange mounts are permanently affixed to lamp
- LEDs have no filament, therefore are extremely resistant to shock & vibration
- Less current draw, resulting in increased battery & alternator life while allowing more power for other vehicle requirements



Part Number	Lamp Connector	Lens Material	Mount Color	Volts	Amps Major / Minor	Diamond Shell
44226R	Fit 'N Forget S.S.	PC	Black	12	0.5 / 0.1	No
44222R	Fit 'N Forget S.S.	PC	Gray	12	0.5 / 0.1	No
44883R	Fit 'N Forget S.S.	AC	Gray	12	0.5 / 0.1	Yes

SUPER 44[®], LED, 42 DIODES, 4" ROUND, FLANGE MOUNT, KIT



- Faster illumination offers significant safety benefit for following drivers to react more quickly, resulting in an average distance of 3' reaction time advantage for every 10 mph
- Flange mounts are permanently affixed to lamp
- LEDs have no filament, therefore are extremely resistant to shock & vibration
- Less current draw, resulting in increased battery & alternator life while allowing more power for other vehicle requirements



Part Number	Lamp Connector	Plug Side 1	Plug Side 2	Lens Material	Mount Color	Volts	Amps Major/Minor	Diamond Shell	Kit Includes/ Replacement Parts
44026R	Fit 'N Forget S.S.	Fit 'N Forget S.S.	Straight Female PL-3	PC	Black	12	0.5 / 0.1	No	94706 plug
44022R	Fit 'N Forget S.S.	Fit 'N Forget S.S.	Straight Female PL-3	PC	Gray	12	0.5 / 0.1	No	94706 plug
44083R	Fit 'N Forget S.S.	Fit 'N Forget S.S.	Straight Female PL-3	AC	Gray	12	0.5 / 0.1	Yes	94706 plug

45[®] SERIES, LED, 15 DIODES, 3"X 5", GROMMET MOUNT

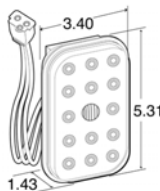

- Mount horizontally or vertically
- Specifically designed for use in trailer & body applications



Part Number	Lamp Connector	Plug Side 1	Plug Side 2	Lens Material	Volts	Amps Major/Minor
45258R	Hardwired	Hardwired	Straight Female PL-3	AC	12 24	0.25 / 0.01

LED

SUPER 44

LED

SUPER 44

LED

45 SERIES

45[®] SERIES, LED, 15 DIODES, 3"X 5", GROMMET MOUNT, KIT



- Mount horizontally or vertically
- Specifically designed for use in trailer & body applications

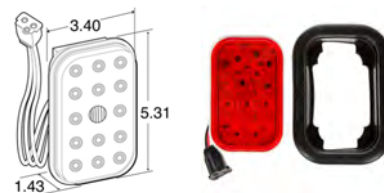

Part Number	Lamp Connector	Plug Side 1	Plug Side 2	Lens Material	Mount Color	Volts	Amps Major/Minor	Kit Includes/ Replacement Parts
45058R	Hardwired	Hardwired	Straight Female PL-3	AC	Black	12 24	0.25/0.01	45700 grommet, 45250 lamp

45[®] SERIES, LED, 15 DIODES, 3"X 5", FLANGE MOUNT



- Mount horizontally or vertically.
- Specifically designed for use in trailer & body applications

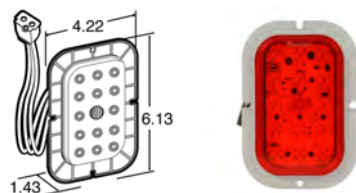

Part Number	Lamp Connector	Plug Side 1	Plug Side 2	Lens Material	Mount Color	Volts	Amps Major/Minor
45259R	Hardwired	Hardwired	Straight Female PL-3	AC	Gray	12 24	0.25 / 0.01

45[®] SERIES, LED, 19 DIODES, 3"X 5", GROMMET MOUNT, KIT



- Direct pin-to-circuit board solders assure vibration resistant contacts
- ECE approved for rear position/stop direction indicator and rear fog functions



Part Number	Lamp Connector	Plug Side 1	Plug Side 2	Lens Material	Mount Color	Volts	Amps Major/Minor	Kit Includes/ Replacement Parts
45042R	Hardwired	Hardwired	.180 Bullet	PC	Black	12 24	0.28 / 0.03	45700 grommet, 45932R lamp

45[®] SERIES, LED, 24 DIODES, 3"X 5", GROMMET MOUNT



- Direct pin-to-circuit board solders assure vibration resistant contacts
- ECE approved for rear position/stop direction indicator and rear fog functions
- Electronics completely sealed in epoxy to resist corrosion & moisture
- Lamps are hardwired with standard 0.180 molded bullet connectors
- LEDs are less susceptible to shock & vibration
- Low current draw, leaving more power for other vehicle universal lighting products

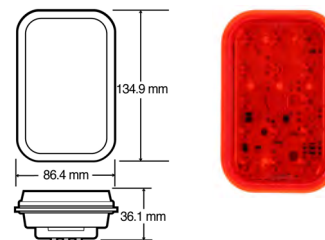

Part Number	Lamp Connector	Plug Side 1	Plug Side 2	Lens Material	Volts	Amps Major/Minor
45932R	Hardwired	Hardwired	.180 Bullet	PC	12 24	0.28/0.03

60[®] SERIES, LED, 8 DIODES, 2" X 6" OVAL, GROMMET MOUNT, S/T/T + BACK-UP COMBO

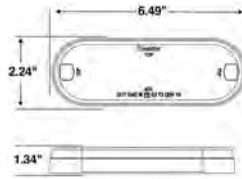

- Offers the same safety and low maintenance benefits of existing LED S/T/T and BU lights now in one package
- Not orientation dependent; complies with FMVSS 108 vertically or horizontally
- Save space in inventory
- Lower-cost system
- The new combination lamps are the same size as existing Truck-Lite Model 60 lights, which means they fit into existing mounting holes



Part Number	Lamp Connector	Lens Material	Lens Color	Volts	Amps Major/Minor	Diamond Shell
60557R	Fit 'N Forget 4 Pin S.S.	PC	Red Clear	12	0.24/0.02	No

60[®] SERIES, LED, 8 DIODES, 2" X 6" OVAL, GROMMET MOUNT, S/T/T + BACK-UP COMBO, HARDWIRED

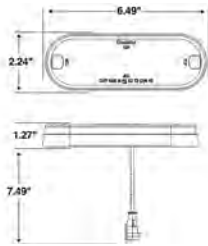

- Offers the same safety and low maintenance benefits of existing LED S/T/T and BU lights now in one package
- Not orientation dependent; complies with FMVSS 108 vertically or horizontally
- Save space in inventory
- Lower-cost system
- The new combination lamps are the same size as existing Truck-Lite Model 60 lights, which means they fit into existing mounting holes



Part Number	Lamp Connector	Plug Side 1	Plug Side 2	Lens Material	Lens Color	Volts	Amps Major/Minor	Diamond Shell
60556R	Hardwired	Hardwired	Fit 'N Forget S.S.	PC	Red Clear	12	0.24/0.02	No

60[®] SERIES, LED, 8 DIODES, 2" X 6" OVAL, SURFACE MOUNT, S/T/T + BACK-UP COMBO

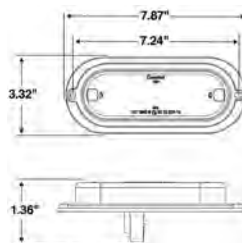

- Offers the same safety and low maintenance benefits of existing LED S/T/T and BU lights now in one package
- Not orientation dependent; complies with FMVSS 108 vertically or horizontally
- Save space in inventory
- Lower-cost system
- The new combination lamps are the same size as existing Truck-Lite Model 60 lights, which means they fit into existing mounting holes



Part Number	Lamp Connector	Lens Material	Lens Color	Mount Color	Volts	Amps Major/Minor	Diamond Shell
60555R	Fit 'N Forget 4 Pin S.S.	PC	Red Clear	Black	12	0.24/0.02	No

60[®] SERIES, LED, 8 DIODES, 2" X 6" OVAL, SURFACE MOUNT, S/T/T + BACK-UP COMBO, HARDWIRED



- Offers the same safety and low maintenance benefits of existing LED S/T/T and BU lights now in one package
- Not orientation dependent; complies with FMVSS 108 vertically or horizontally
- Save space in inventory
- Lower-cost system
- The new combination lamps are the same size as existing Truck-Lite Model 60 lights, which means they fit into existing mounting holes



Part Number	Lamp Connector	Plug Side 1	Plug Side 2	Lens Material	Lens Color	Mount Color	Volts	Amps Major/Minor	Diamond Shell
60554R	Hardwired	Hardwired	Fit 'N Forget S.S.	PC	Red Clear	Black	12	0.24/0.02	No

60[®] SERIES, LED, 8 DIODES, 2" X 6" OVAL, FLUSH MOUNT, S/T/T + BACK-UP COMBO



- Offers the same safety and low maintenance benefits of existing LED S/T/T and BU lights now in one package
- Not orientation dependent; complies with FMVSS 108 vertically or horizontally
- Save space in inventory
- Lower-cost system
- The new combination lamps are the same size as existing Truck-Lite Model 60 lights, which means they fit into existing mounting holes

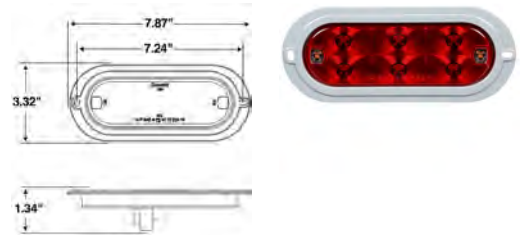

Part Number	Lamp Connector	Lens Material	Lens Color	Mount Color	Volts	Amps Major/Minor	Diamond Shell
60552R	Fit 'N Forget 4 Pin S.S.	PC	Red Clear	Black	12	0.24/0.02	No
60553R	Fit 'N Forget 4 Pin S.S.	PC	Red Clear	Gray	12	0.24/0.02	No

60[®] SERIES, LED, 8 DIODES, 2" X 6" OVAL, FLUSH MOUNT, S/T/T + BACK-UP COMBO, HARDWIRED



- Offers the same safety and low maintenance benefits of existing LED S/T/T and BU lights now in one package
- Not orientation dependent; complies with FMVSS 108 vertically or horizontally
- Save space in inventory
- Lower-cost system
- The new combination lamps are the same size as existing Truck-Lite Model 60 lights, which means they fit into existing mounting holes



Part Number	Lamp Connector	Plug Side 1	Plug Side 2	Lens Material	Lens Color	Mount Color	Volts	Amps Major/Minor	Diamond Shell
60550R	Hardwired	Hardwired	.180 Bullet	PC	Red Clear	Black	12	0.24/0.02	No
60551R	Hardwired	Hardwired	Fit 'N Forget S.S.	PC	Red Clear	Gray	12	0.24/0.02	No

60[®] SERIES, LED, 18 DIODES, 2"X 6" OVAL, FLANGE MOUNT

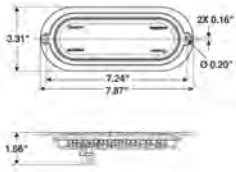

- Features a PL-3 connector
- Ideal for vehicles featuring liftgates
- Shallow curved lens profile allows for flush mounting in applications where space is at a premium



Part Number	Lamp Connector	Lens Material	Mount Color	Volts	Amps Major / Minor	Diamond Shell
60356R	PL-3	PC	Black	12	0.36/0.07	No

60[®] SERIES, LED, 26 DIODES, 2"X 6" OVAL, GROMMET MOUNT

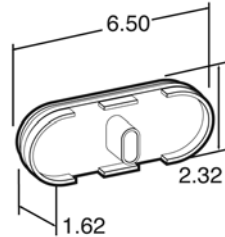

- Faster illumination offers significant safety benefit for following drivers to react quicker, resulting in average 3' reaction time advantage for every 10 mph



Part Number	Lamp Connector	Lens Material	Volts	Amps Major / Minor	Diamond Shell
60250R	Fit 'N Forget S.S.	PC	12	0.34/0.04	No
60253R	Fit 'N Forget S.S.	PC	24	0.34/0.04	No
60264R	Fit 'N Forget S.S.	AC	24	0.34/0.04	Yes
60885R	Fit 'N Forget S.S.	AC	12	0.34/0.04	Yes

60[®] SERIES, LED, 26 DIODES, 2"X 6" OVAL, GROMMET MOUNT, KIT

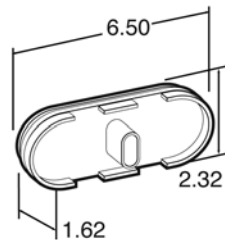

- Faster illumination offers significant safety benefit for following drivers to react quicker, resulting in average 3' reaction time advantage for every 10 mph



Part Number	Lamp Connector	Plug Side 1	Plug Side 2	Lens Material	Mount Color	Volts	Amps Major/Minor	Diamond Shell	Kit Includes/ Replacement Parts
60050R	Fit 'N Forget S.S.	Fit 'N Forget S.S.	Straight Female PL-3	PC	Black	12	0.34/0.04	No	4700 grommet, 94706 plug
60085R	Fit 'N Forget S.S.	Fit 'N Forget S.S.	Straight Female PL-3	AC	Black	12	0.34/0.04	Yes	4700 grommet, 94706 plug

60[®] SERIES, LED, 26 DIODES, 2"X 6" OVAL, FLANGE MOUNT



- Faster illumination offers significant safety benefit for following drivers to react more quickly, resulting in average 3' reaction time advantage for every 10 mph

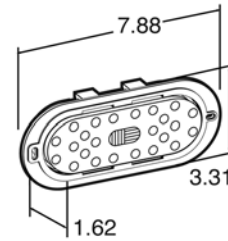

Part Number	Lamp Connector	Lens Material	Mount Color	Volts	Amps Major / Minor	Diamond Shell
60252R	Fit 'N Forget S.S.	PC	Gray	12	0.34/0.04	No
60256R	Fit 'N Forget S.S.	PC	Black	12	0.34/0.04	No

LED

60 SERIES

60[®] SERIES, LED, 26 DIODES, 2"X 6" OVAL, FLANGE MOUNT, KIT



- Faster illumination offers significant safety benefit for following drivers to react more quickly, resulting in average 3' reaction time advantage for every 10 mph

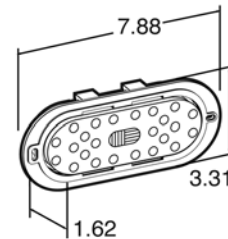

Part Number	Lamp Connector	Plug Side 1	Plug Side 2	Lens Material	Mount Color	Volts	Amps Major/Minor	Diamond Shell	Kit Includes/ Replacement Parts
60052R	Fit 'N Forget S.S.	Fit 'N Forget S.S.	Straight Female PL-3	PC	Gray	12	0.34/0.04	No	4700 grommet, 94706 plug
60056R	Fit 'N Forget S.S.	Fit 'N Forget S.S.	Straight Female PL-3	PC	Black	12	0.34/0.04	No	4700 grommet, 94706 plug

LED

60 SERIES

SUPER 66, LED, 1 DIODE, 2"X 6" OVAL, GROMMET MOUNT



- Designed to look more like a standard incandescent lamp but has more light output
- Less current draw, resulting in increased battery & alternator life while allowing more power for other vehicle requirements
- World's first single diode LED stop, turn & tail lamp

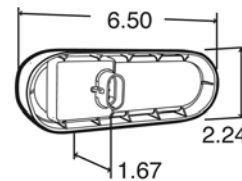

Part Number	Lamp Connector	Lens Material	Volts	Amps Major / Minor	Diamond Shell
66250R	Fit 'N Forget S.S.	PC	12	0.47/0.03	No

LED

SUPER 66

SUPER 66, LED, 1 DIODE, 2"X 6" OVAL, GROMMET MOUNT, KIT

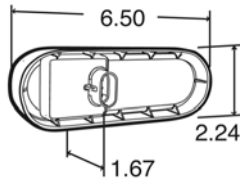

- Designed to look more like a standard incandescent lamp but has more light output
- Less current draw, resulting in increased battery & alternator life while allowing more power for other vehicle requirements
- World's first single siode LED stop, turn & tail lamp



Part Number	Lamp Connector	Plug Side 1	Plug Side 2	Lens Material	Mount Color	Volts	Amps Major/Minor	Diamond Shell	Kit Includes/ Replacement Parts
66885R	Fit 'N Forget S.S.	Fit 'N Forget S.S.	Straight Female PL-3	AC	Black	12	0.47/0.03	Yes	4700 grommet, 94706 plug
66050R	Fit 'N Forget S.S.	Fit 'N Forget S.S.	Straight Female PL-3	PC	Black	12	0.47/0.03	No	4700 grommet, 94706 plug
66085R	Fit 'N Forget S.S.	Fit 'N Forget S.S.	Straight Female PL-3	AC	Black	12	0.47/0.03	Yes	4700 grommet, 94706 plug

SUPER 66, LED, 1 DIODE, 2"X 6" OVAL, FLANGE MOUNT

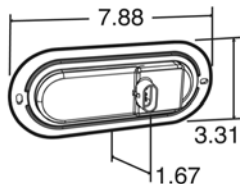

- Designed to look more like a standard incandescent lamp but has more light output
- Less current draw, resulting in increased battery & alternator life while allowing more power for other vehicle requirements
- World's first single siode LED stop, turn & tail lamp



Part Number	Lamp Connector	Lens Material	Mount Color	Volts	Amps Major / Minor	Diamond Shell
66252R	Fit 'N Forget S.S.	PC	Gray	12	0.47/0.03	No
66254R	Fit 'N Forget S.S.	PC	White	12	0.47/0.03	No
66256R	Fit 'N Forget S.S.	PC	Black	12	0.47/0.03	No
66882R	Fit 'N Forget S.S.	AC	Gray	12	0.47/0.03	Yes

SUPER 66, LED, 1 DIODE, 2"X 6" OVAL, FLANGE MOUNT, KIT

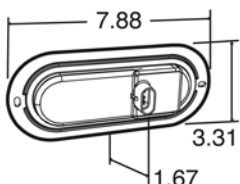

- Designed to look more like a standard incandescent lamp but has more light output
- Less current draw, resulting in increased battery & alternator life while allowing more power for other vehicle requirements
- World's first single siode LED stop, turn & tail lamp



Part Number	Lamp Connector	Plug Side 1	Plug Side 2	Lens Material	Mount Color	Volts	Amps Major/Minor	Diamond Shell	Kit Includes/ Replacement Parts
66052R	Fit 'N Forget S.S.	Fit 'N Forget S.S.	Straight Female PL-3	PC	Gray	12	0.47/0.03	No	66252R lamp, 97406 plug
66054R	Fit 'N Forget S.S.	Fit 'N Forget S.S.	Straight Female PL-3	PC	White	12	0.47/0.03	No	66254R lamp, 97406 plug
66056R	Fit 'N Forget S.S.	Fit 'N Forget S.S.	Straight Female PL-3	PC	Black	12	0.47/0.03	No	66256R lamp, 97406 plug
66082R	Fit 'N Forget S.S.	Fit 'N Forget S.S.	Straight Female PL-3	AC	Gray	12	0.47/0.03	Yes	66882R lamp, 97406 plug

SIGNAL-STAT, LED, 10 DIODES, 4" ROUND, GROMMET MOUNT



- Uses standard PL-3 connector When properly mounted, exceeds FMVSS-P2 DOT requirements for marker/clearance performance
- Designed with impact-resistant acrylic material
- Sealed lens and housing locks moisture out
- Snap fit grommet requires no screws for installation LEDs do not have a filament, therefore are not susceptible to shock and vibration damage major cause of failure for lamps with an incandescent bulb.
- Epoxy encapsulated electronics prevents damage from moisture and corrosion.

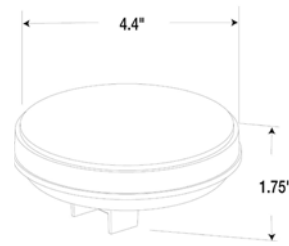

Part Number	Lamp Connector	Lens Material	Volts	Amps Major/Minor
4058	PL-3	AC	12	0.12 / 0.02

SIGNAL-STAT, LED, 24 DIODES, 4" ROUND, GROMMET MOUNT



- Epoxy encapsulated electronics prevents damage from moisture & corrosion
- Unique LED array displays a full pattern light output design
- Uses standard right angle connection

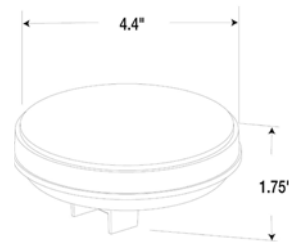

Part Number	Lamp Connector	Lens Material	Lens Color	Volts	Amps Major/Minor
4050	PL-3	PC	Red	12	0.14 / 0.01
4051	PL-3	PC	Red Clear	12	0.14 / 0.01

SIGNAL-STAT, LED, 24 DIODES, 4" ROUND, FLANGE MOUNT



- Uses standard right angle PL-3 connection
- Designed with impact-resistant polycarbonate material
- LEDs do not have a filament, therefore are not susceptible to damage from shock and vibration
- Epoxy encapsulated electronics prevents damage from moisture and corrosion
- When properly mounted, exceeds FMVSS DOT requirements for S/T/T and F/P/T

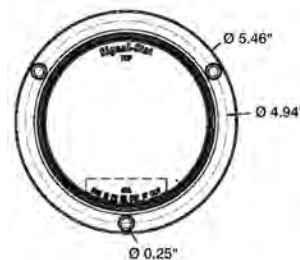

Part Number	Lamp Connector	Lens Material	Mount Color	Volts	Amps Major/Minor
4053	PL-3	PC	Gray	12	0.14 / 0.01

SIGNAL-STAT, LED, 10 DIODES, 2"X 6" OVAL, GROMMET MOUNT

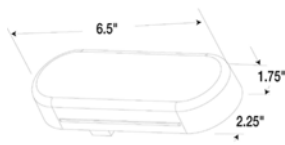

- When properly mounted, exceeds FMVSS-P2 DOT requirements for marker/clearance performance
- Designed with impact-resistant acrylic material
- Sealed lens and housing locks moisture out
- Snap fit grommet requires no screws for installation
- LEDs do not have a filament, therefore are not susceptible to damage from shock and vibration
- Epoxy encapsulated electronics prevents damage from moisture and corrosion
- Popular on owner/operator and show trucks



Part Number	Lamp Connector	Lens Material	Volts	Amps Major / Minor
6058	PL-3	AC	12	0.17/0.02

SIGNAL-STAT, LED, 24 DIODES, 2"X 6" OVAL, GROMMET MOUNT

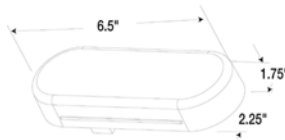

- Epoxy encapsulated electronics prevents damage from moisture & corrosion
- Unique LED array displays full pattern light output design
- Uses standard right angle plug



Part Number	Lamp Connector	Lens Material	Lens Color	Volts	Amps Major / Minor
6050	PL-3	PC	Red	12	0.26/0.02
6051	PL-3	PC	Red Clear	12	0.26/0.02

SIGNAL-STAT, LED, 24 DIODES, 2"X 6" OVAL, FLANGE MOUNT

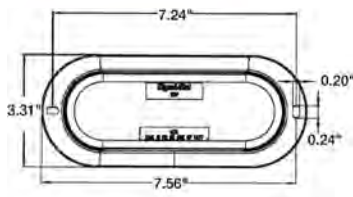

- Housing and flange are molded together to form one piece
- Uses standard right angle PL-3 connection
- Designed with impact-resistant polycarbonate material
- LEDs do not have a filament, therefore are not susceptible to shock and vibration damage - a major cause of failure for lamps with an incandescent bulb
- Epoxy encapsulated electronics prevents damage from moisture and corrosion
- When properly mounted, exceeds FMVSS DOT requirements for S/T/T and F/P/T



Part Number	Lamp Connector	Lens Material	Mount Color	Volts	Amps Major / Minor
6053	PL-3	PC	Gray	12	0.26/0.02

SIGNAL-STAT, LED, 10 DIODES, 3"X 5" REC., GROMMET MOUNT



- Uses standard right angle PL-3 connection
- Unique LED array displays full pattern light output Epoxy encapsulated electronics

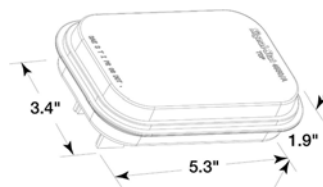

Part Number	Lamp Connector	Lens Material	Volts	Amps Major/Minor
4558	PL-3	AC	12	0.28 / 0.03

LED

SIGNAL-STAT

SIGNAL-STAT, LED, 24 DIODES, 3"X 5" REC., GROMMET MOUNT



- 24 diode pattern
- Unique LED array displays full pattern light output
- Uses standard right angle PL-3 connection



Part Number	Lamp Connector	Lens Material	Volts	Amps Major/Minor
4550	PL-3	AC	12	0.38 / 0.03

LED

SIGNAL-STAT

Keep Your Connections Safe. Don't Forget Your Dielectric Gel.

Dielectric gel protects your lights by protecting the points of contact between elements of your lighting and harness system. Our dielectric compounds prevent arcing and corrosion and keep your lights performing as they should.

You can find our dielectric products on page 498



40[®] SERIES, INCANDESCENT, 1 BULB, 4" ROUND, GROMMET MOUNT

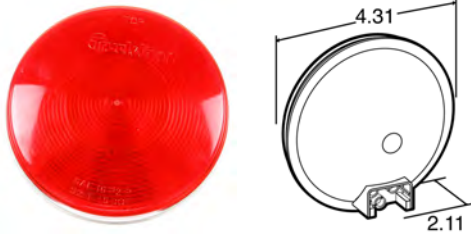

- Shock mount absorbs road shock & vibration, extending lamp life
- Welded connections eliminate failures caused by arcing
- Heavy-duty bulb offers long-lasting life
- Features clear back housing
- Grommet kit features flush mounting in a 4-1/2" hole
- Not recommended for clearance marker applications
- Welded connections eliminate failures caused by arcing



Part Number	Lamp Connector	Lens Material	Volts	Amps Major/Minor
40202R	PL-3	PC	12	2.1/0.48
40209R	PL-3	PC	24	0.93/0.34
49202R	Male Pin	PC	12	2.1/0.48

40[®] SERIES, INCANDESCENT, 1 BULB, 4" ROUND, GROMMET MOUNT, KIT



- Flush-mount grommets are designed for mounting in a 4-1/2" hole
- Heavy-duty bulb last longer
- Shock mount absorbs road shock & vibration, extending lamp life
- Welded connections eliminate failures caused by arcing



Part Number	Lamp Connector	Plug Side 1	Plug Side 2	Lens Material	Mount Color	Volts	Amps Major/Minor	Kit Includes/ Replacement Parts
40002R	PL-3	Right Angle PL-3	Stripped End/ Ring Terminal	PC	Black	12	2.1/0.48	40700 grommet, 94993 plug, 40202R lamp
40009R	PL-3	Right Angle PL-3	Stripped End/ Ring Terminal	PC	Black	24	0.93/0.34	40700 grommet, 94993 plug, 40209R lamp
49002R	Male Pin	Male Pin	Stripped End/ Ring Terminal	PC	Black	12	2.1/0.48	40700 grommet, 96107 plug

40[®] SERIES, INCANDESCENT, 1 BULB, 4" ROUND, GROMMET MOUNT, SNAP FIT, KIT



- Replaces 40302R/Y and 40318R/Y
- Polycarbonate lens and housing
- Grommet features flush mounting in a 4-1/2" hole



Part Number	Lamp Connector	Plug Side 1	Plug Side 2	Lens Material	Mount Color	Volts	Amps Major/Minor	Kit Includes/ Replacement Parts
40302R	Twist Socket	Twist Socket	Stripped End/ Ring Terminal	PC	Black	12	2.1/0.48	40700 grommet, 94938 bulb/plug, 99010R housing

40[®] SERIES, INCANDESCENT, 1 BULB, 4" ROUND, GROMMET MOUNT, CLEAR BACK



- Features clear back housing
- Shock mount absorbs road shock & vibration, extending lamp life
- Welded connections eliminate failures caused by arcing
- Heavy-duty bulb offers long-lasting life
- Uniquely designed shock-mount extends lamp life
- Not recommended for clearance marker applications
- Welded connections eliminate failures caused by arcing

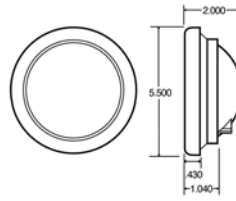

Part Number	Lamp Connector	Lens Material	Volts	Amps Major/Minor
40206R	PL-3	PC	12	2.1/0.48

INCANDESCENT

40 SERIES

40[®] SERIES, INCANDESCENT, 1 BULB, 4" ROUND, GROMMET MOUNT, CLEAR BACK, KIT



- Features clear back housing
- Not recommended for clearance marker applications
- Grommet kit features flush mounting in a 4-1/2" hole

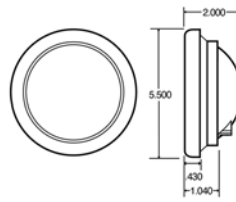

Part Number	Lamp Connector	Plug Side 1	Plug Side 2	Lens Material	Mount Color	Volts	Amps Major/Minor	Kit Includes/ Replacement Parts
40006R	PL-3	Right Angle PL-3	Stripped End/ Ring Terminal	PC	Black	12	2.1/0.48	40700 grommet, 94993 plug, 40206R lamp

INCANDESCENT

40 SERIES

40[®] SERIES, INCANDESCENT, 1 BULB, GROMMET MOUNT, REFLECTORIZED



- Flush mount grommets are designed for mounting in a 4-1/2" hole
- Heavy-duty bulb offers long-lasting life
- Reflectorized lens
- Uniquely designed shock-mount extends lamp life

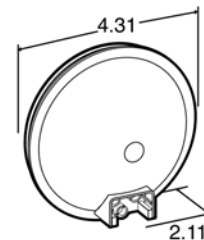

Part Number	Lamp Connector	Lens Material	Volts	Amps Major/Minor
40215R	PL-3	PC	12	2.1/0.48
40232R	PL-3	PC	24	0.93/0.34

INCANDESCENT

40 SERIES

40[®] SERIES, INCANDESCENT, 1 BULB, 4" ROUND, GROMMET MOUNT, REFLECTORIZED, KIT

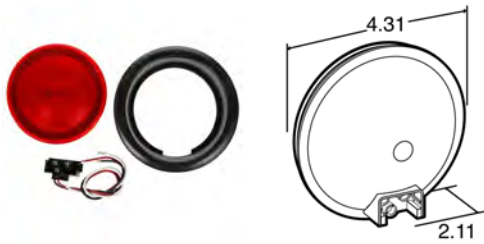

- Flush-mount grommets are designed for mounting in a 4-1/2" hole
- Heavy-duty bulb offers long-lasting life
- Reflectorized lens
- Uniquely designed shock-mount extends lamp life



Part Number	Lamp Connector	Plug Side 1	Plug Side 2	Lens Material	Mount Color	Volts	Amps Major/Minor	Kit Includes/ Replacement Parts
40015R	PL-3	Right Angle PL-3	Stripped End/Ring Terminal	PC	Black	12	2.1 / 0.48	40700 grommet, 94993 plug, 40215R lamp

40[®] SERIES, INCANDESCENT, 1 BULB, 4" ROUND, FLANGE MOUNT

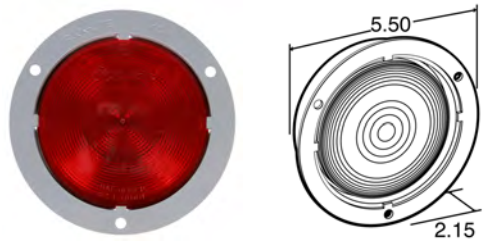

- Flush-mount grommets are designed for mounting in a 4-1/2" hole
- Gray flange mounts are permanently affixed to housing



Part Number	Lamp Connector	Lens Material	Mount Color	Volts	Amps Major/Minor
40222R	PL-3	PC	Gray	12	2.1/0.48

40[®] SERIES, INCANDESCENT, 1 BULB, 4" ROUND, FLANGE MOUNT, KIT

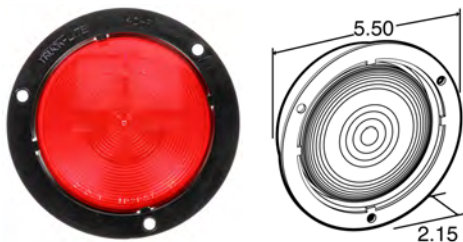

- Flush-mount grommets are designed for mounting in a 4-1/2" hole
- Heavy-duty bulb offers long-lasting life
- Uniquely designed shock-mount extends lamp life



Part Number	Lamp Connector	Plug Side 1	Plug Side 2	Lens Material	Mount Color	Volts	Amps Major/Minor
40233R	PL-3	Right Angle PL-3	Stripped End/Ring Terminal	PC	Black	12	2.1/0.48

40[®] ECONOMY, INCANDESCENT, 1 BULB, 4" ROUND, GROMMET MOUNT



- Flange kits feature a high impact plastic affixed to lamp
- Grommet kit features flush mounting in a 4-1/2" hole

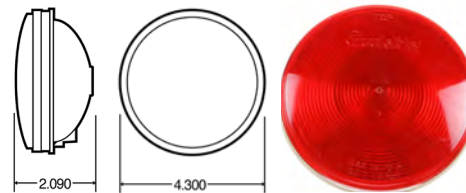

Part Number	Lamp Connector	Lens Material	Volts	Amps Major/Minor
40282R	PL-3	PC	12	2.1/0.48

INCANDESCENT

40 ECONOMY

40[®] ECONOMY, INCANDESCENT, 1 BULB, 4" ROUND, GROMMET MOUNT, KIT



- Flange kits feature a high-impact plastic affixed to lamp
- Grommet kit features flush mounting in a 4-1/2" hole

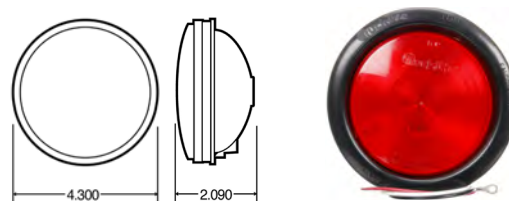

Part Number	Lamp Connector	Plug Side 1	Plug Side 2	Lens Material	Mount Color	Volts	Amps Major/Minor	Kit Includes/ Replacement Parts
40028R	PL-3	Right Angle PL-3	Stripped End/ Ring Terminal	PC	Black	12	2.1/0.48	40700 grommet, 94993 plug, 40282R lamp

INCANDESCENT

40 ECONOMY

Keep Your Connections Safe. Don't Forget Your Dielectric Gel.

Dielectric gel protects your lights by protecting the points of contact between elements of your lighting and harness system. Our dielectric compounds prevent arcing and corrosion and keep your lights performing as they should.

You can find our dielectric products on page 498



40[®] ECONOMY, INCANDESCENT, 1 BULB, 4" ROUND, GROMMET MOUNT, REFLECTORIZED

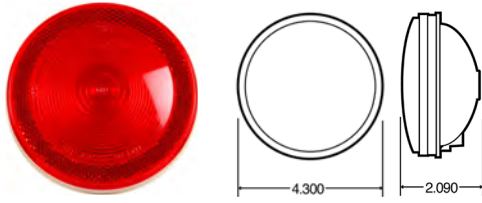

- Flange kits feature a high impact plastic affixed to lamp
- Grommet kit features flush mounting in a 4-1/2" hole



Part Number	Lamp Connector	Lens Material	Volts	Amps Major/Minor
40285R	PL-3	PC	12	2.16/0.47

40[®] ECONOMY, INCANDESCENT, 1 BULB, 4" ROUND, FLANGE MOUNT

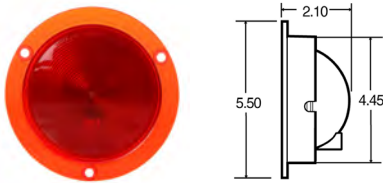

- Flange kits feature a high impact plastic affixed to lamp
- Grommet kit features flush mounting in a 4-1/2" hole



Part Number	Lamp Connector	Lens Material	Mount Color	Volts	Amps Major/Minor
40229R	PL-3	PC	Red	12	2.16/0.47

40[®] ECONOMY, INCANDESCENT, 1 BULB, 4" ROUND, FLANGE MOUNT, KIT

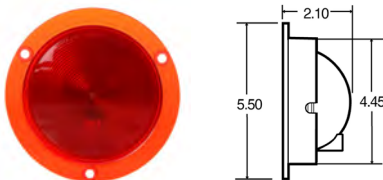

- Flange kits feature a high impact plastic affixed to lamp
- Grommet kit features flush mounting in a 4-1/2" hole



Part Number	Lamp Connector	Plug Side 1	Plug Side 2	Lens Material	Mount Color	Volts	Amps Major/Minor	Kit Includes/ Replacement Parts
40029R	PL-3	Straight PL-3	Stripped End/ Ring Terminal	PC	Red	12	2.16/0.47	40229R lamp, 94993 plug

SUPER 40[®], INCANDESCENT, 1 BULB, 4" ROUND, GROMMET MOUNT



- Uniquely designed shock-mount extends lamp life

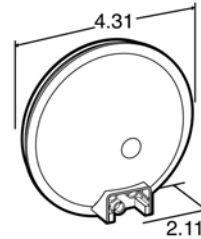

Part Number	Lamp Connector	Lens Material	Volts	Amps Major/Minor
40242R	PL-3	PC	12	2.16/0.47

INCANDESCENT

SUPER 40

SUPER 40[®], INCANDESCENT, 1 BULB, 4" ROUND, GROMMET MOUNT, KIT



- 8 square inch (illuminating) stop/turn lens area for vehicles under 80 inches wide
- Meets reflex, tail or clearance function for vehicles over 80 inches wide (Use part# 40248R)
- Flush-mount grommets are designed for mounting in a 4 1/2" hole
- Uniquely designed shock-mount extends lamp life
- Upgrade to LED lighting systems using Truck-Lite's Super 44 series

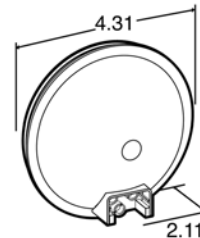

Part Number	Lamp Connector	Plug Side 1	Plug Side 2	Lens Material	Mount Color	Volts	Amps Major/Minor	Kit Includes/ Replacement Parts
40042R	PL-3	Right Angle PL-3	Stripped End/ Ring Terminal	PC	Black	12	2.16/0.47	40700 grommet, 94993 plug, 40242R lamp

INCANDESCENT

SUPER 40

SUPER 40[®], INCANDESCENT, 1 BULB, 4" ROUND, GROMMET MOUNT, REFLECTORIZED



- Uniquely designed shock-mount extends lamp life

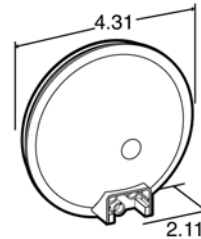

Part Number	Lamp Connector	Lens Material	Volts	Amps Major/Minor
40248R	PL-3	PC	12	2.16/0.47

INCANDESCENT

SUPER 40

SUPER 40[®], INCANDESCENT, 1 BULB, 4" ROUND, GROMMET MOUNT, REFLECTORIZED, KIT

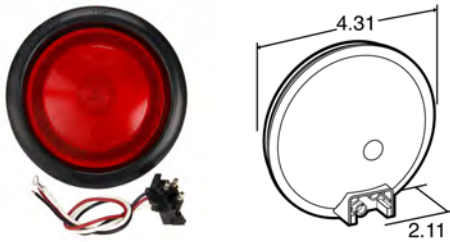

- Flush mount grommets are designed for mounting in a 4-1/2" hole
- ReflectORIZED lens



Part Number	Lamp Connector	Plug Side 1	Plug Side 2	Lens Material	Mount Color	Volts	Amps Major/Minor	Kit Includes/ Replacement Parts
40048R	PL-3	Right Angle PL-3	Stripped End/ Ring Terminal	PC	Black	12	2.16/0.47	40700 grommet, 94993 plug, 40248R lamp

SUPER 40[®], INCANDESCENT, 1 BULB, 4" ROUND, FLANGE MOUNT

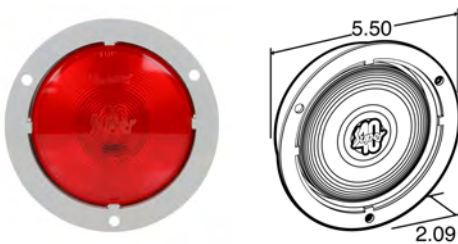

- Uniquely designed shock-mount extends lamp life



Part Number	Lamp Connector	Lens Material	Mount Color	Volts	Amps Major/Minor
40258R	PL-3	PC	Gray	12	2.16/0.47
40259R	PL-3	PC	Black	12	2.16/0.47

SUPER 40[®], INCANDESCENT, 1 BULB, 4" ROUND, FLANGE MOUNT, KIT

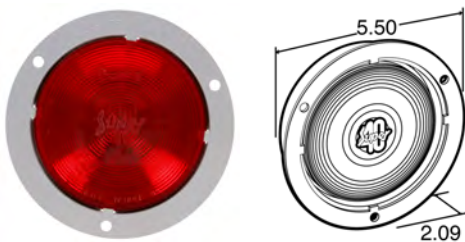

- Uniquely designed shock-mount extends lamp life



Part Number	Lamp Connector	Plug Side 1	Plug Side 2	Lens Material	Mount Color	Volts	Amps Major/Minor	Kit Includes/ Replacement Parts
40058R	PL-3	Right Angle PL-3	Stripped End/ Ring Terminal	PC	Gray	12	2.16/0.47	94993 plug, 40258R lamp

41 SERIES, INCANDESCENT, 1 BULB, 3"X 5", FLANGE MOUNT



- Mounts in 7.83" x 4.43" hole
- Requires separate reflector to meet legal requirements

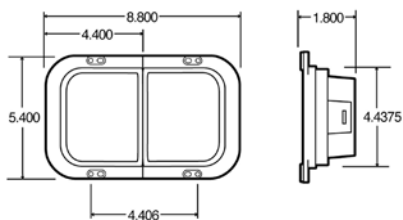

Part Number	Position	Lamp Connector	Lens Material	Mount Color	Volts	Amps Major/Minor
41202R	LH	PL-3	PC	White	12	2.1/0.48
41203R	RH	PL-3	PC	White	12	2.1/0.48

INCANDESCENT

41 SERIES

41 SERIES, INCANDESCENT, 1 BULB, 3"X 5", FLANGE MOUNT, KIT



- Mounts in 7.83" x 4.43" hole
- Requires separate reflector to meet legal requirements

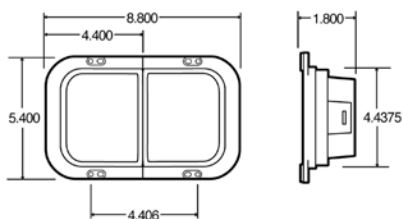

Part Number	Position	Lamp Connector	Plug Side 1	Plug Side 2	Lens Material	Mount Color	Volts	Amps Maj/Min	Kit Includes/ Replacement Parts
41005R	LH	PL-3	Straight PL-3	Ring Terminal/Molded Four-Position .180	PC	White	12	2.1/0.48	94948 plug, 41202R lamp, 41203R lamp
41006R	RH	PL-3	Straight PL-3	Ring Terminal/Molded Four-Position .180	PC	White	12	2.1/0.48	94949 plug, 41202R lamp, 41203R lamp
41007R	Universal	PL-3	Straight PL-3	Stripped End/ Ring Terminal	PC	White	12	2.1/0.48	94926 plug, 41202R lamp, 41203R lamp
41008R	Universal	PL-3	Straight PL-3	Ring Terminal/ 2-Position Plug	PC	White	12	2.1/0.48	41202R, 41203R lamp

INCANDESCENT

41 SERIES

SUPER 45[®], INCANDESCENT, 1 BULB, 3"X 5", GROMMET MOUNT



- Heavy-duty dual filament cartridge bulb
- Mount horizontally or vertically
- Unique shock mount absorbs shock & vibration

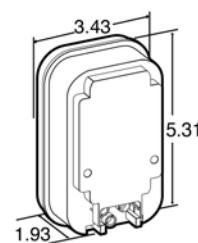

Part Number	Lamp Connector	Lens Material	Volts	Amps Major/Minor
45202R	PL-3	PC	12	2.16/0.47

INCANDESCENT

SUPER 45

SUPER 45[®], INCANDESCENT, 1 BULB, 3"X 5" REC., GROMMET MOUNT, KIT

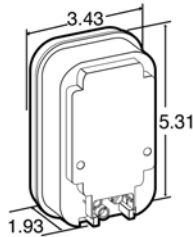

- Heavy-duty dual filament cartridge bulb
- Mount horizontally or vertically
- Unique shock mount absorbs shock & vibration



Part Number	Lamp Connector	Plug Side 1	Plug Side 2	Lens Material	Mount Color	Volts	Amps Major/Minor	Kit Includes/ Replacement Parts
45002R	PL-3	Hardwired	Stripped End/ Ring Terminal	PC	Black	12	2.16/0.47	94993 plug, 45700 grommet, 45202R lamp

60[®] SERIES, INCANDESCENT, 1 BULB, 2"X 6" OVAL, GROMMET MOUNT, HARDWIRED, KIT

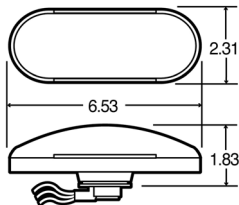

- Lamp may be either grommet or screw-mounted
- Mounts horizontally or vertically



Part Number	Lamp Connector	Plug Side 1	Plug Side 2	Lens Material	Mount Color	Volts	Amps Major/Minor	Kit Includes/ Replacement Parts
60302R	Hardwired	Hardwired	Stripped End/ Ring Terminal	PC	Gray	12	2.1/0.48	99011R lamp
60340R	Hardwired	Hardwired	Stripped End/ Ring Terminal	PC	Black	12	2.1/0.48	95407 bulb, 99184R lamp

60[®] ECONOMY, INCANDESCENT, 1 BULB, 2"X 6" OVAL, GROMMET MOUNT

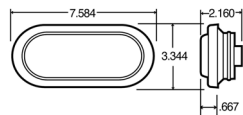

- Contains a heavy-duty dual filament bulb
- Mounts horizontally or vertically



Part Number	Lamp Connector	Lens Material	Volts	Amps Major/Minor
60283R	PL-3	PC	12	2.1/0.48

60[®] ECONOMY, INCANDESCENT, 1 BULB, 2"X 6" OVAL, GROMMET MOUNT, KIT



- Contains a heavy-duty dual filament bulb
- Mounts horizontally or vertically

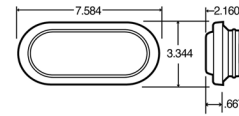

Part Number	Lamp Connector	Plug Side 1	Plug Side 2	Lens Material	Mount Color	Volts	Amps Major/Minor	Kit Includes/ Replacement Parts
60083R	PL-3	PL-3	Stripped End/ Ring Terminal	PC	Black	12	2.1/0.48	94993 plug, 60700 grommet, 60283R lamp

INCANDESCENT

60 ECONOMY

SUPER 60[®], INCANDESCENT, 1 BULB, 2"X 6" OVAL, GROMMET MOUNT



- Mounts horizontally or vertically
- Right angle plug assembly

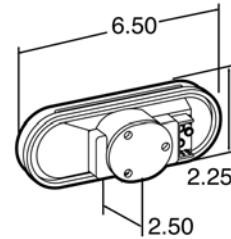

Part Number	Lamp Connector	Lens Material	Volts	Amps Major/Minor
60202R	PL-3	PC	12	2.1/0.48
60207R	PL-3	PC	24	0.93/0.34

INCANDESCENT

SUPER 60

SUPER 60[®], INCANDESCENT, 1 BULB, 2"X 6" OVAL, GROMMET MOUNT, KIT



- Mounts horizontally or vertically
- Right angle plug assembly

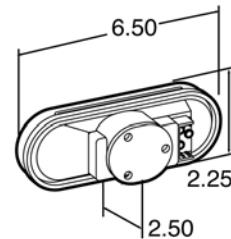

Part Number	Lamp Connector	Plug Side 1	Plug Side 2	Lens Material	Mount Color	Volts	Amps Major/Minor	Kit Includes/ Replacement Parts
60002R	PL-3	PL-3	Stripped End/ Ring Terminal	PC	Black	12	2.1/0.48	60700 grommet, 60202R lens, 94993 plug
60007R	PL-3	PL-3	Stripped End/ Ring Terminal	PC	Black	24	0.93/0.34	60083R grommet, 60207R lens

INCANDESCENT

SUPER 60

80 SERIES, INCANDESCENT, 1 BULB, 4" ROUND, FLANGE MOUNT, HARDWIRED

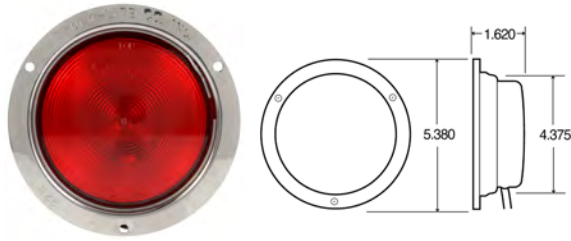

- Mounts flush to vehicle with recessed lens
- Features rubber housing for shock absorbcency



Part Number	Lamp Connector	Plug Side 1	Plug Side 2	Lens Material	Mount Color	Volts	Amps Major/Minor	Housing Material
80302R	Hardwired	Hardwired	Blunt Cut	AC	Black	12	2.25/1.44	Stainless Steel
80335R	Hardwired	Hardwired	Blunt Cut	PC	Silver	12	2.25/1.44	Unpolished Steel
80336R	Hardwired	Hardwired	Blunt Cut	PC	Silver	12	2.25/1.44	Polished Steel
80339R	Hardwired	Hardwired	Blunt Cut	PC	Black	12	2.25/1.44	

80 SERIES, INCANDESCENT, 1 BULB, 4" ROUND, FLANGE MOUNT, HARDWIRED, KIT

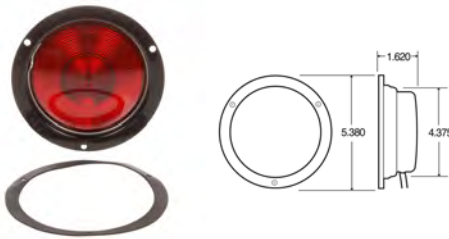

- Mounts flush to vehicle



Part Number	Lamp Connector	Plug Side 1	Plug Side 2	Lens Material	Mount Color	Volts	Amps Major/Minor	Kit Includes/ Replacement Parts
80334R	Hardwired	Hardwired	Blunt Cut	PC	Black	12	2.25/1.44	94993 plug, 60700 grommet, 60283R lamp

80 SERIES, INCANDESCENT, 1 BULB, 4" ROUND, STUD MOUNT, HARDWIRED

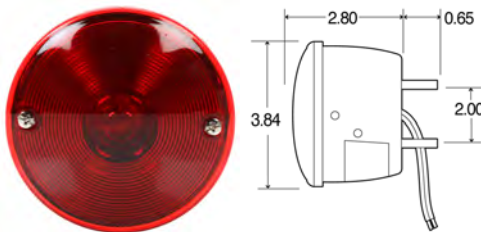

- Universal or 2 bolt mount 1/4" - 20
- Dual screws secure lens



Part Number	Lamp Connector	Plug Side 1	Plug Side 2	Lens Material	Lens Color	Mount Color	Mount Type	Volts	Amps Major/Minor
80461R	Hardwired	Hardwired	Stripped End	AC	Red/Clear	Black	Bracket	12	2.25/1.44
80462R	Hardwired	Hardwired	Stripped End	AC	Red	Black	Bracket	12	2.25/1.44
80463R	Hardwired	Hardwired	Stripped End	AC	Red/Clear	Black		12	2.25/1.44

90 SERIES, INCANDESCENT, 1 BULB, 7" ROUND, 4 SCREW



- Popular lamp on many school buses and emergency vehicles
- Recess mounts in a 5.25" diameter hole, 2.37" deep and uses four bolts on a 6.25" bolt circle

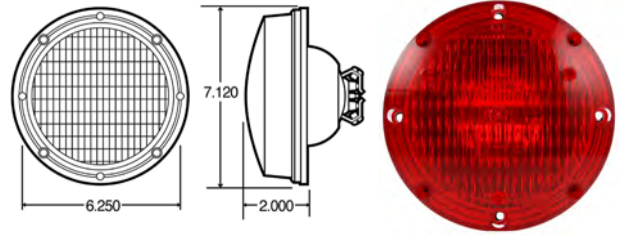

Part Number	Lamp Connector	Lens Material	Volts	Amps Major/Minor
90326R	Two Screw Terminal	AC	12	2.1/0.59

INCANDESCENT

90 SERIES

90 SERIES, INCANDESCENT, 1 BULB, 7" ROUND, 4 SCREW, HARDWIRED



- Popular lamp on many school buses and emergency vehicles
- Recess mounts in a 5.25" diameter hole, 2.37" deep and uses four bolts on a 6.25" bolt circle

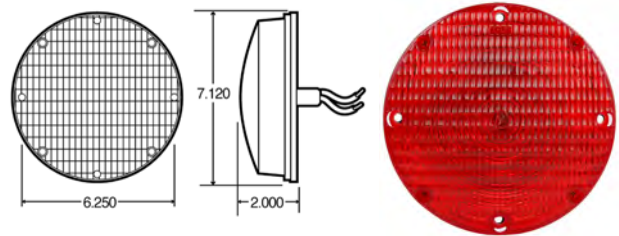

Part Number	Lamp Connector	Plug Side 1	Plug Side 2	Lens Material	Volts	Amps Major/Minor
90327R	Hardwired	Hardwired	Stripped End	AC	12	2.1/0.59

INCANDESCENT

90 SERIES

Keep Your Connections Safe. Don't Forget Your Dielectric Gel.

Dielectric gel protects your lights by protecting the points of contact between elements of your lighting and harness system. Our dielectric compounds prevent arcing and corrosion and keep your lights performing as they should.

You can find our dielectric products on page 498



91® SERIES, INCANDESCENT, 1 BULB, 7" ROUND, 4 SCREW

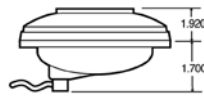
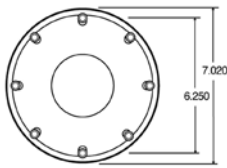

- Contains a heavy-duty shock mount
- 12 volt dual filament bulb
- Mounting gasket provides additional protection between lamp & body
- Mounts in a 5.375" hole



Part Number	Lamp Connector	Lens Material	Volts	Amps Major/Minor
91202R	PL-3	PC	12	2.1/0.48
91205R	PL-3	PC	24	0.93/0.34

91® SERIES, INCANDESCENT, 1 BULB, 7" ROUND, 4 SCREW, KIT

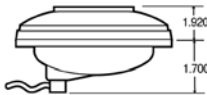
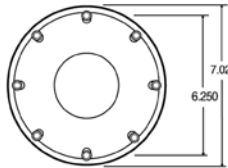

- Contains a heavy-duty shock mount
- 12 volt dual filament bulb
- Mounting gasket provides additional protection between lamp & body
- Mounts in a 5.375" hole



Part Number	Lamp Connector	Plug Side 1	Plug Side 2	Lens Material	Volts	Amps Major/Minor	Kit Includes/ Replacement Parts
91002R	PL-3	PL-3	Stripped End/Ring Terminal	PC	12	2.1/0.48	94993 plug, 91202R lamp

91® SERIES, INCANDESCENT, 1 BULB, 7" ROUND, 4 SCREW, HARDWIRED

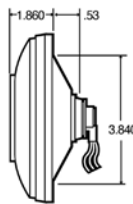
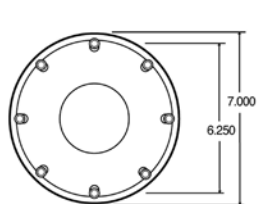

- Mounting gasket provides additional protection between lamp & body
- Mounts in a 3.84" hole



Part Number	Lamp Connector	Plug Side 1	Plug Side 2	Lens Material	Volts	Amps Major/Minor
91315R	Hardwired	Hardwired	Stripped End/Ring Terminal	PC	12	2.1/0.48

INCANDESCENT

91 SERIES

INCANDESCENT, RECTANGULAR, 4 SCREW, 4" X 6", SOCKET ASSEMBLY



- Recess mounts using two screws at 3.0" centers and two screws at 4.2" centers

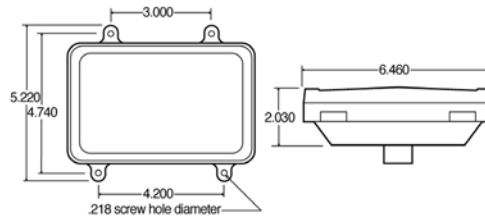

Part Number	Lamp Connector	Lens Material
07098	Socket Assembly	PC

INCANDESCENT

4 SCREW

INCANDESCENT, 1 BULB, RECTANGULAR, 4 SCREW, 4" X 6"



- Recess mounts using two screws at 3.0" centers and two screws at 4.2" centers
- Watertight lamp mates with Packard connector
- 12v lamps mate with P.E. Connector 6288471

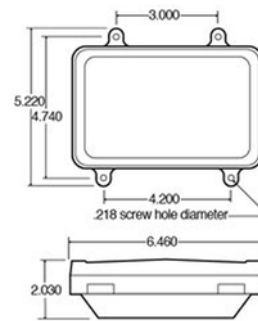

Part Number	Lamp Connector	Lens Material	Volts	Amps Major/Minor
07081	Blade Terminal	PC	12	2.1/0.48
07092	Blade Terminal	PC	12	2.1/0.48
07093	Blade Terminal	PC	24	3.1/1.48

INCANDESCENT

4 SCREW

21[®] SERIES, LED, 16 DIODES, 2"X6", BRACKET MOUNT, KIT

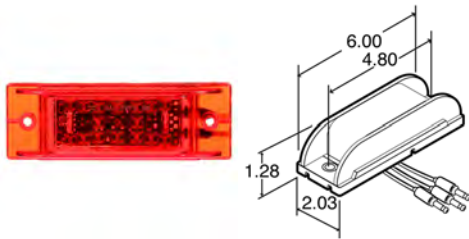

- Optional gaskets available to improve seal between lamp and body
- Electronics completely sealed in epoxy to resist corrosion and moisture
- Hardwired design eliminates pin corrosion
- Recommended for use in center high mounted stop lamp applications only



Part Number	Lamp Connector	Plug Side 1	Plug Side 2	Lens Color	Lens Material	Volts	Amps Major/Minor	Kit Includes/ Replacement Parts
21271R	Hardwired	Hardwired	.180 Bullet	Red	PC	12	0.14/0.04	

60[®] SERIES, LED, 26 DIODES, 2"X6", GROMMET MOUNT

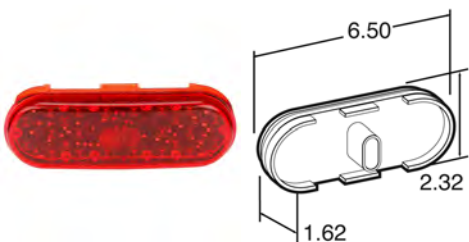

- Recommended for auxiliary brake light applications only
- Electronics completely sealed in epoxy to resist corrosion and moisture



Part Number	Lamp Connector	Lens Color	Lens Material	Mount Color	Volts	Amps Major/Minor
60260R	Fit 'N Forget S.S.	Red	PC		12	0.21/0.04

60[®] SERIES, LED, 26 DIODES, 2"X6", GROMMET MOUNT, KIT



- Recommended for auxiliary brake light applications only
- Electronics completely sealed in epoxy to resist corrosion and moisture



Part Number	Lamp Connector	Plug Side 1	Plug Side 2	Lens Color	Lens Material	Mount Color	Volts	Amps Major/Minor	Kit Includes/ Replacement Parts
60061R	Fit 'N Forget S.S.	Fit 'N Forget S.S.	Straight PL-2	Red	PC	Black	12	0.21/0.04	60260R lens, 60700 grommet, 94789 plug
60060R	Fit 'N Forget S.S.	Fit 'N Forget S.S.	Packard Connector 12020398	Red	PC	Black	12	0.21/0.04	45701 grommet, 60701 grommet

60[®] SERIES, LED, 26 DIODES, 2"X6", FLANGE MOUNT



- Recommended for auxiliary brake light applications only
- Electronics completely sealed in epoxy to resist corrosion and moisture

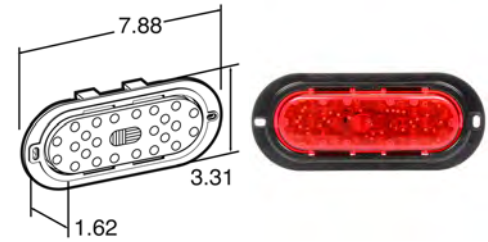

Part Number	Lamp Connector	Lens Color	Lens Material	Mount Color	Volts	Amps Major/Minor
60266R	Fit 'N Forget S.S.	Red	PC	Black	12	0.21/0.04
60262R	Fit 'N Forget S.S.	Red	PC	Gray	12	0.21/0.04

60[®] SERIES, LED, 26 DIODES, 2"X6", FLANGE MOUNT, KIT



- Recommended for auxiliary brake light applications only
- Electronics completely sealed in epoxy to resist corrosion and moisture



Part Number	Lamp Connector	Plug Side 1	Plug Side 2	Lens Color	Lens Material	Mount Color	Volts	Amps Major/Minor	Kit Includes/ Replacement Parts
60062R	Fit 'N Forget S.S.	Fit 'N Forget S.S.	Straight PL-2	Red	PC	Gray	12	0.21/0.04	60262R lens, 94789 plug

LED, 9 DIODES, 1"X9", ADHESIVE MOUNT, KIT



- Slim lamp welcomes applications where space is at a premium
- Adhesive back adheres to mounting surface without the need for installation screws or brackets
- Peel-and-stick design makes for a tight, unbreakable seal
- DOT/SAE compliant
- 96" wire lead makes wiring easier
- Recommended for use in center high-mounted stop lamp applications only

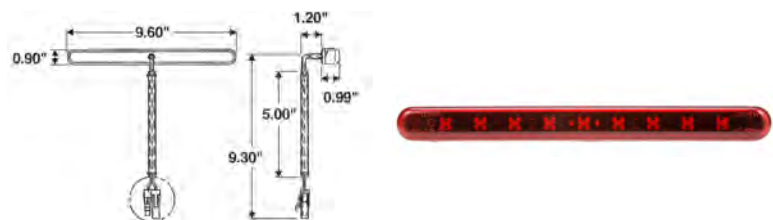

Part Number	Lamp Connector	Plug Side 1	Plug Side 2	Lens Color	Lens Material	Volts	Amps Major/Minor
92101	Hardwired	Hardwired	Packard Connector	Red	PC	12	0.23
92100	Hardwired	Hardwired	Stripped End	Red	PC	12	0.23

40[®] SERIES, INCANDESCENT, 1 BULB, 4", GROMMET MOUNT

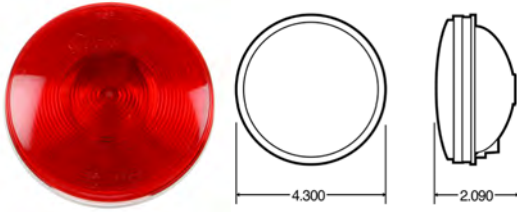

- Features high-mount stop function when center mounted on the top rear of the vehicle
- Heavy-duty, shock-mounted bulb
- Recommended for use in center high mount stop lamp applications only



Part Number	Lamp Connector	Lens Color	Lens Material	Mount Color	Volts	Amps Major/Minor
40247R	PL-3	Red	PC		12	1.44

45[®] SERIES, INCANDESCENT, 1 BULB, 3"X5", GROMMET MOUNT



- Features high mount stop function when center mounted on the top rear of the vehicle
- Heavy-duty, shock-mounted bulb
- Recommended for use in center high-mounted stop lamp applications

Part Number	Lamp Connector	Lens Color	Lens Material	Mount Color	Volts	Amps Major/Minor
45207R	PL-3	Red	PC	Black	12	1.44

45[®] SERIES, INCANDESCENT, 1 BULB, 3"X5", GROMMET MOUNT, KIT

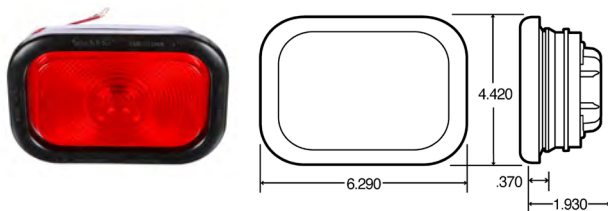

- Features high mount stop function when center mounted on the top rear of the vehicle
- Heavy-duty, shock-mounted bulb
- Recommended for use in center high-mounted stop lamp applications



Part Number	Lamp Connector	Plug Side 1	Plug Side 2	Lens Color	Lens Material	Mount Color	Volts	Amps Major/Minor	Kit Includes/ Replacement Parts
45007R	PL-2	PL-2	Stripped End/Ring Terminal	Red	PC	Black	12	1.44	45207R lens, 45700 grommet, 94992 plug

60[®] SERIES, INCANDESCENT, 1 BULB, 2"X6", GROMMET MOUNT

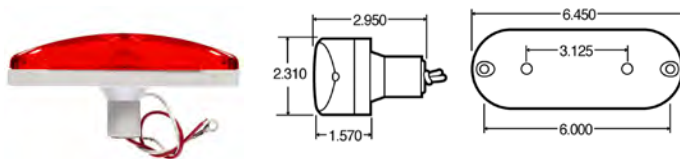

- Lamp may be either grommet or screw-mounted
- Mounts horizontally or vertically
- .250 Internal Knockout hole / 1.620 clearance hole
- Upgrade to Truck-Lite LED lighting systems using 60 Series LED products



Part Number	Lamp Connector	Plug Side 1	Plug Side 2	Lens Color	Lens Material	Volts	Amps Major/Minor
60303R	Hardwired	Hardwired	Stripped End/Ring Terminal	Red	PC	12	1.44

60[®] SERIES, INCANDESCENT, 1 BULB, 2"X6", GROMMET MOUNT, KIT



- Features high-mount stop function when center mounted on the top rear of the vehicle
- Single filament bayonet-base bulb
- Uses standard mounting holes & accessories
- Welded lamp grommet mounts

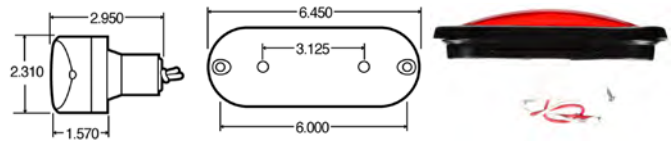

Part Number	Lamp Connector	Plug Side 1	Plug Side 2	Lens Color	Lens Material	Mount Color	Volts	Amps Major/Minor	Kit Includes
60324R	Hardwired	Hardwired	Stripped End Ring Terminal	Red	PC	Black	12	1.44	99011R lens, 60700 grommet, 60789 housing

INCANDESCENT

60 SERIES

SUPER 60[®], INCANDESCENT, 1 BULB, 2"X6", GROMMET MOUNT



- Features high-mount stop function when center mounted on the top rear of the vehicle
- Heavy-duty, shock-mounted bulb
- Recommended for auxiliary brake light applications only
- Upgrade to Truck-Lite LED Systems using part #60061R or 60260R

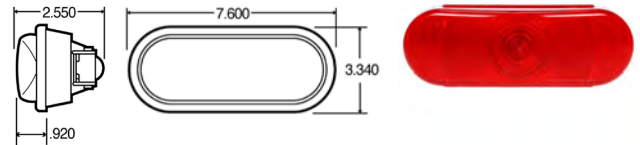

Part Number	Lamp Connector	Lens Color	Lens Material	Volts	Amps Major/Minor
60213R	PL-2	Red	PC	12	1.44

INCANDESCENT

60 SERIES

SUPER 60[®], INCANDESCENT, 1 BULB, 2"X6", GROMMET MOUNT, KIT



- Features high-mount stop function when center mounted on the top rear of the vehicle
- Heavy-duty shock-mounted bulb
- Recommended for auxiliary brake light applications only
- Upgrade to Truck-Lite LED Systems using part #60061R or 60260R

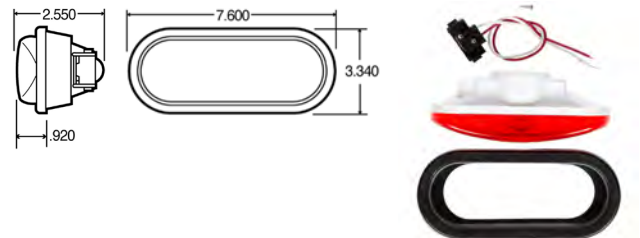

Part Number	Lamp Connector	Plug Side 1	Plug Side 2	Lens Color	Lens Material	Mount Color	Volts	Amps Major/Minor	Kit Includes
60013R	PL-2	Right Angle PL-2	Stripped End Ring Terminal	Red	PC	Black	12	1.44	60213R lens, 60700 grommet, 94992 plug

INCANDESCENT

SUPER 60

LED

SIGNAL-STAT

SIGNAL-STAT, LED, 2 STUD MOUNT

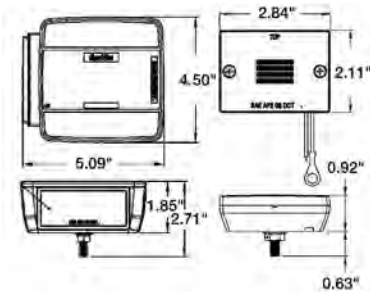

- Kit provides all legal lamps & reflective products for trailers less than 80" wide
- Popular on camping, motorcycle, horse & utility trailers



Part Number	Position	License Lamp	Lamp Connection	Plug Side 1	Plug Side 2	Lens Material	Volts	Amps Major/Minor
5055D	RH	No	Hardwired	Hardwired	Stripped End	AC	12	0.16/0.05
5056D	LH	No	Hardwired	Hardwired	Stripped End	AC	12	0.16/0.05

LED

SIGNAL-STAT

SIGNAL-STAT, LED, 3 STUD MOUNT

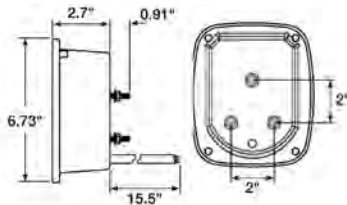

- Kit provides all legal lamps & reflective products for trailers less than 80" wide
- Popular on camping, motorcycle, horse & utility trailers



Part Number	Position	License Lamp	Lamp Connection	Plug Side 1	Plug Side 2	Lens Material	Volts	Amps Major/Minor
5070	LH	Yes	Hardwired	Hardwired	Stripped End	AC	12	0.14/0.06
5071	RH	No	Hardwired	Hardwired	Stripped End	AC	12	0.14/0.06
5072	LH	Yes	Hardwired	Hardwired	Packard Connector/ Ring Terminal	AC	12	0.14/0.06
5073	RH	No	Hardwired	Hardwired	Packard Connector/ Ring Terminal	AC	12	0.14/0.06

INCANDESCENT

FORD

SIGNAL-STAT, LED, 3 STUD MOUNT, FORD

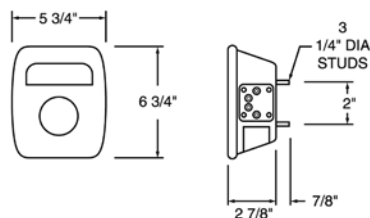

- Ford #D9HZ13405A and B (curbside)
- Ford #D9HZ13404A and B (roadside)
- Fits 1979 and later Ford models
- Freightliner #A06-13581-001 (curbside)
- Freightliner #A06-13581-000 (roadside)
- Includes junction box cover
- Rear lamp assembly combining stop, tail, turn, back-up and reflex reflector



Part Number	Position	License Lamp	Lamp Connection	Lens Material	Volts	Amps Major/Minor
4023	RH	Yes	Stud Terminal	PC	12	2.25/0.59
4024	LH	Yes	Stud Terminal	PC	12	2.25/0.59

SIGNAL-STAT, LED, 2 STUD MOUNT, FORD/DODGE



- Dodge Truck #3895020 and 3895021
- Ford #DOTZ13404A, D3KZ13404A, D3TZ13403B, E2TB13404A and E2TB13405A
- Combination stop, tail, turn, back-up lamp with reflex reflector replaces Dodge and Ford truck models
- Universal rear pigtail connection
- Dual-optic lens and housing molded from tough polycarbonate with high heat and impact resistance

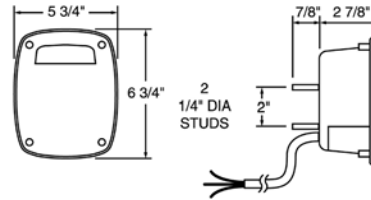

Part Number	Position	License Lamp	Lamp Connection	Plug Side 1	Plug Side 2	Lens Material	Volts	Amps Major/Minor
4028		Yes	Hardwired	Hardwired	Stripped End	PC	12	2.1/0.59

SIGNAL-STAT, LED, 3 STUD MOUNT, FREIGHTLINER



- Ford #D9HZ13405A and B (curbside)
- Ford #D9HZ13404A and B (roadside)
- Fits 1979 and later Ford models
- Freightliner #A06-13581-001 (curbside)
- Freightliner #A06-13581-000 (roadside)
- Includes junction box cover
- Rear lamp assembly combining stop, tail, turn, back-up and reflex reflector

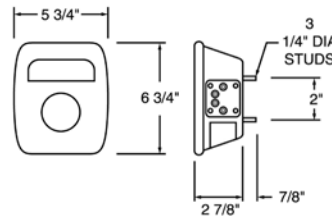

Part Number	Position	License Lamp	Lamp Connection	Lens Material	Volts	Amps Major/Minor
4023Y106	RH	Yes	Stud Terminal	Acrylic	12	2.25/0.59
4024Y106	LH	Yes	Stud Terminal	Acrylic	12	2.25/0.59

SIGNAL-STAT, LED, 3 STUD MOUNT, FREIGHTLINER/PETERBILT/GM



- 5024: Freightliner #681-544-0503 Peterbilt #16-06291 Volvo GM #8067855
- 5023: Freightliner #681-544-0503 Peterbilt #16-06291 Volvo GM #8067855

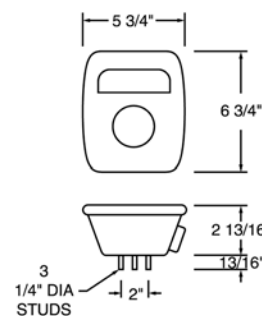

Part Number	Position	License Lamp	Lamp Connection	Lens Material	Volts	Amps Major/Minor
5023	LH	Yes	Packard Connector 12020116/ Packard Connector 12066271	PC	12	2.1/0.59
5024	RH	Yes	Packard Connector 12066271/ Packard Connector 12020116	PC	12	2.1/0.59

SIGNAL-STAT, LED, 3 STUD MOUNT, FREIGHTLINER/PETERBILT/GM/OSHKOSH

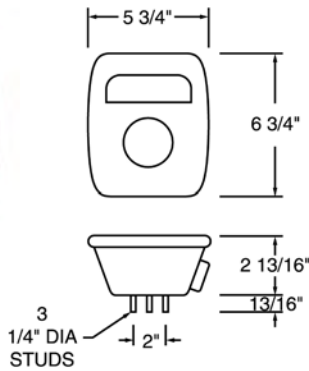

- 5013, 5013K: GM #15565731, 15574697, 15613943, 15684994 Oshkosh #2078210 Peterbilt #16-06160L
- 5014: GM #15565732, 15574696, 15613944, 15684995 Freightliner #681-544-04-03 Oshkosh #2078200 Peterbilt #16-06160R, 16-06292
- 5023Y102: Navistar #1661281C91



Part Number	Position	License Lamp	Lamp Connection	Plug Side 1	Plug Side 2	Lens Material	Volts	Amps Major/Minor
5013	LH	Yes	Packard Connector 12066271			PC	12	2.1/0.59
5013K	LH	Yes	Packard Connector	Packard Connector	Stripped End	PC	12	2.1/0.59
5014	RH	No	Packard Connector			PC	12	2.1/0.59
5014K	RH	No	Packard Connector	Packard Connector	Stripped End	PC	12	2.1/0.59

SIGNAL-STAT, LED, 3 STUD MOUNT, NAVISTAR

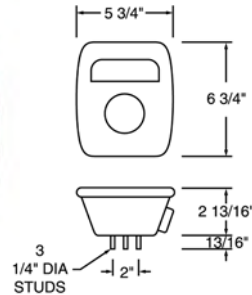

- 5023Y102: Navistar #1661281C91



Part Number	Position	License Lamp	Lamp Connection	Lens Material	Volts	Amps Major/Minor
5014Y102	RH	No	Packard Connector 12034047	PC	12	2.1/0.59
5023Y102	LH	Yes	Packard Connector 12020116/ Packard Connector 12034047	PC	12	2.1/0.59

INCANDESCENT

FREIGHTLINER / PETERBILT / GM / OSHKOSH

INCANDESCENT

NAVISTAR

SIGNAL-STAT, LED, 3 STUD MOUNT, NAVISTAR



- Navistar #1661281C91
- Navistar #1661282C91
- RH lamp popular replacement for GM/IH OE #56139474, #15565732
- Combination stop, tail, turn, back-up and reflex reflector
- Dual-optic acrylic lens
- Permastat body provides impact resistance
- 5315Y101 has dual Metri-Pack connectors-one on either side of the lamp
- 5315Y101 uses #9470 main harness
- 5316Y101 uses #9469 jumper harness

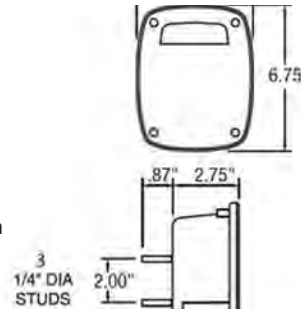

Part Number	Position	License Lamp	Lamp Connection	Lens Material	Volts	Amps Major/Minor
5315Y101	LH	Yes	Packard Connector	PC	12	2.1/0.59
5316Y101	RH	Yes	Packard Connector	PC	12	2.1/0.59

INCANDESCENT

NAVISTAR

SIGNAL-STAT, LED, 3 STUD MOUNT, NAVISTAR



- Navistar #467707C91 and 424538C91 (LH).
- Navistar #467708C91 and 424539C91 (RH).
- Includes junction box cover.

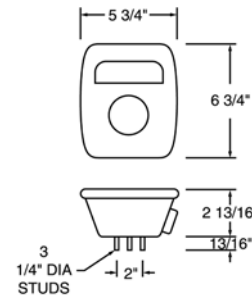

Part Number	Position	License Lamp	Lamp Connection	Lens Material	Volts	Amps Major/Minor
4015	LH	Yes	Blade Terminal	PC	12	2.1/0.59
4016	RH	Yes	Blade Terminal	PC	12	2.1/0.59

INCANDESCENT

NAVISTAR

SIGNAL-STAT, LED, 3 STUD MOUNT, VOLVO



- 5014Y101: Volvo GM #8067856

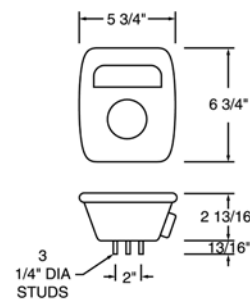

Part Number	Position	License Lamp	Lamp Connection	Lens Material	Volts	Amps Major/Minor
5014Y101	Volvo	No	Packard Connector 12066271	PC	12	2.1/0.59

INCANDESCENT

VOLVO

INCANDESCENT, 2 STUD MOUNT

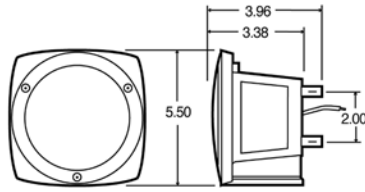

- Features reflectorized lens
- 2 bolt mounting
- Available with or without license window



Part Number	License Lamp	Lamp Connection	Plug Side 1	Plug Side 2	Lens Material	Volts	Amps Major/Minor
80322R	No	Hardwired	Hardwired	Blunt Cut	AC	12	2.1/0.27
80324R	Yes	Hardwired	Hardwired	Blunt Cut	AC	12	2.1/0.27

SIGNAL-STAT, INCANDESCENT, 3 STUD MOUNT

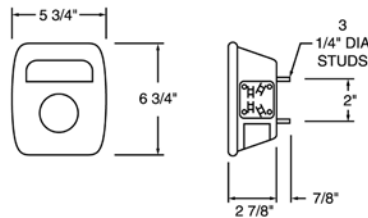

- Replaces all GM medium and heavy-duty 1972 to 1985
- Integral housing with 3 bolt mount
- Includes junction box cover



Part Number	Position	License Lamp	Lamp Connection	Lens Material	Volts	Amps Major/Minor
4017	LH	No	Screw Terminal	PC	12	2.1/0.59
4018	RH	Yes	Screw Terminal	PC	12	2.1/0.59

SIGNAL-STAT, INCANDESCENT, 3 STUD MOUNT, HARDWIRED

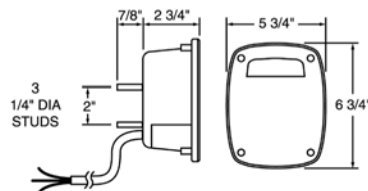

- Combination stop/turn/tail, back-up and reflex reflector
- Three bolt on 2" triangle
- Upgrade to LED Truck-Lite LED Products using #5070-#5073



Part Number	Packaging Type	License Lamp	Lamp Connection	Plug Side 1	Plug Side 2	Lens Material	Volts	Amps Major/Minor
4027	Standard	No	Hardwired	Hardwired	Stripped End	AC	12	2.1/0.59
4027D	Display	No	Hardwired	Hardwired	Stripped End	AC	12	2.1/0.59

Looking for even more product information?

Visit truck-lite.com



Powerful Search



360° Product Images



Easy-To-Find Replacement Parts

SIGNAL LIGHTING

TURN SIGNAL LIGHTS

Pages 58-75

LED

SERIES	COMMON SIZE	PAGES
Super 44®	4"	58-59
45® Series	3" x 5"	60-61
60® Series	2" x 6"	62-65
Super 60®	2" x 6"	66-67

INCANDESCENT

SERIES	COMMON SIZE	PAGES
20 Series	2"	68
22® Series	2" x 6"	68
40® Series	7" x 13"	69
Super 40®	4"	69
45® Series	3" x 5"	70
Super 45®	3" x 5"	70
60® Series	2" x 6"	70-71
Super 60®	2" x 6"	71-72
Signal Stat Round	6"	72
Signal-Stat Oval	2" x 6"	72-73
Signal-Stat Square	7" x 7"	73
Round 1 Bulb	4"	74
Oval 1 Bulb	2" x 6"	74
Rectangular 1 Bulb	4" x 6"	75

FRONT / PARK / TURN

Pages 76-92

LED

SERIES	COMMON SIZE	PAGES
Super 44®	4"	76-79
60® Series	2" x 6"	80-81
91® Series	7"	82
Signal-Stat Round	4"	83
Signal-Stat Oval	2" x 6"	84

INCANDESCENT

SERIES	COMMON SIZE	PAGES
40® Series	4"	86
40® Economy	4"	87
Super 45®	3" x 5"	88
60® Series	2" x 6"	88-89
Super 60®	2" x 6"	89-90
60® Economy	2" x 6"	90
91® Series	7"	91
7in 1 Bulb	7"	92
4in x 6in 1 Bulb	4" x 6"	92
6in x 10in 1 Bulb	6" x 10"	92
4in 1 Bulb	4"	92

LONG LIFE VEHICLE LIGHTING (LLV)

Page 93

LED

SERIES	PAGES
45® Series	93

INCANDESCENT

SERIES	PAGES
60® Series	93

PEDESTAL LIGHTS

Pages 94-105

LED

SERIES	PAGES
Single Face	94
Dual Face	94-95

INCANDESCENT

SERIES	PAGES
Signal Face Round	96-98
Dual Face Round	98-101
Signal Face Square	102
Dual Face Square	102-105







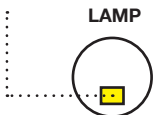
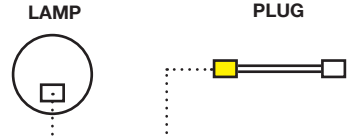
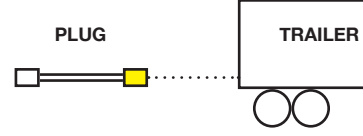

Signal Lighting

Truck-Lite’s LED turn signal lighting is designed to exceed legal requirements and increase conspicuity when correctly mounted. With faster illumination time, other drivers on the road are able to react more quickly.

<p>Shapes</p>	<p>Round, Oval, Rectangular</p>
<p>Mount Types</p>	<p>Grommet, Flange, Bracket, 2 Screw, 4 Screw, Adhesive, 2 Bolt, 1 Stud, 2 Stud</p>
<p>Connection Information</p> <p>When it comes to choosing the correct lamps for your truck or trailer, it’s important to know the connection type on your vehicle’s harness.</p> <p>If the harness connector type does not match your desired light (lamp connector), you will need a plug to complete the connection.</p>	<p>Lamp Connector</p> <p>The connector type located on the back of a lamp</p> 
	<p>Plug Side 1</p> <p>The connection between a plug and a lamp</p> 
	<p>Plug Side 2</p> <p>The connection between a plug and a trailer’s harness</p> 

(800) 562-5012 | truck-lite.com

 <p>Manufacturing & Quality</p>	 <p>Testing & Safety</p>
<p>Truck-Lite’s LED marker/clearance lighting is built using premium materials and backed by industry-leading warranties. Designed to last the life of your vehicle, Truck-Lite’s solid-state construction and sealed circuitry mean that you can depend on your lighting to withstand shock, vibration, moisture and debris.</p>	<p>All Truck-Lite lamps are subjected to rigorous environmental, electrical and mechanical testing before they are validated and released to the market.</p> <p>All lamps comply with FMVSS/CMVSS-108, SAE and DOT standards when properly mounted.</p>
 <p>Performance & Maintenance</p>	 <p>Customer Support</p>
<ul style="list-style-type: none"> • Lower energy consumption, allowing more power for other vehicle requirements • Impact-resistant lenses and rugged housing protect against damage from even the toughest applications • Sealed electronics resist damage caused by moisture and corrosion • Reduced lighting costs associated with physical damage and heat entrapment 	<p>Customer Service</p> <p>(800) 562-5012 customerservice@truck-lite.com</p> <p>Technical Support</p> <p>(888) 562-5012 tltech@truck-lite.com</p> <p>Signal Lighting Warranties</p>   
<p>(800) 562-5012 truck-lite.com</p>	

SUPER 44[®], LED, 42 DIODES, 4" ROUND, GROMMET MOUNT



- Less current draw, resulting in increased battery and alternator life while allowing more power for other vehicle requirements
- Faster illumination offers significant safety benefit for following drivers to react more quickly, resulting in an average of 3' reaction time advantage for every 10 m.p.h.
- LEDs do not have a filament, therefore are not susceptible to damage from shock and vibration



Part Number	Lamp Connector	Lens Material	Volts	Amps Major/Minor
44201Y	Fit 'N Forget S.S.	PC	12	0.65/0.42
44881Y	Fit 'N Forget S.S.	AC	12	0.65/0.42

SUPER 44[®], LED, 42 DIODES, 4" ROUND, GROMMET MOUNT, KIT



- Less current draw, resulting in increased battery and alternator life while allowing more power for other vehicle requirements
- Faster illumination offers significant safety benefit for following drivers to react more quickly, resulting in an average of 3' reaction time advantage for every 10 m.p.h.
- LEDs do not have a filament, therefore are not susceptible to damage from shock and vibration



Part Number	Lamp Connector	Plug Side 1	Plug Side 2	Lens Material	Mount Color	Volts	Amps Major/Minor	Kit Includes/ Replacement Parts
44001Y	Fit 'N Forget S.S.	Fit 'N Forget S.S.	Straight Female PL-3	PC	Black	12	0.65/0.42	40700 grommet, 44201Y lamp

Keep Your Connections Safe. Don't Forget Your Dielectric Gel.

Dielectric gel protects your lights by protecting the points of contact between elements of your lighting and harness system. Our dielectric compounds prevent arcing and corrosion and keep your lights performing as they should.

You can find our dielectric products on page 498



SUPER 44[®], LED, 42 DIODES, 4" ROUND, FLANGE MOUNT



- Less current draw, resulting in increased battery and alternator life while allowing more power for other vehicle requirements
- Faster illumination offers significant safety benefit for following drivers to react more quickly, resulting in an average of 3' reaction time advantage for every 10 m.p.h.
- LEDs do not have a filament, therefore are not susceptible to damage from shock and vibration



Part Number	Lamp Connector	Lens Material	Mount Color	Volts	Amps Major / Minor
44221Y	Fit 'N Forget S.S.	PC	Gray	12	0.65/0.42
44227Y	Fit 'N Forget S.S.	PC	Black	12	0.65/0.42
44231Y	Fit 'N Forget S.S.	PC	White	12	0.65/0.42
44276Y	Fit 'N Forget S.S.	PC	Black	24	0.26/0.02
44887Y	Fit 'N Forget S.S.	AC	Gray	12	0.65/0.42
44888Y	Fit 'N Forget S.S.	AC	Black	12	0.65/0.42

SUPER 44[®], LED, 42 DIODES, 4" ROUND, FLANGE MOUNT, KIT



- Less current draw, resulting in increased battery and alternator life while allowing more power for other vehicle requirements
- Faster illumination offers significant safety benefit for following drivers to react more quickly, resulting in an average of 3' reaction time advantage for every 10 m.p.h.
- LEDs do not have a filament, therefore are not susceptible to damage from shock and vibration



Part Number	Lamp Connector	Plug Side 1	Plug Side 2	Lens Material	Mount Color	Volts	Amps Major/Minor	Kit Includes/ Replacement Parts
44021Y	Fit 'N Forget S.S.	Fit 'N Forget S.S.	Straight Female PL-3	PC	Gray	12	0.65/0.42	94789 plug, 44221Y lamp
44027Y	Fit 'N Forget S.S.	Fit 'N Forget S.S.	Straight Female PL-3	PC	Black	12	0.65/0.42	94789 plug, 44221Y lamp

LED
45 SERIES

45[®] SERIES, LED, 19 DIODES, 3"X 5" RECTANGULAR, GROMMET MOUNT

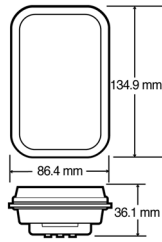

- OmniVolt[®] universal lighting products address increasing vehicle power demands by operating equally in electrical systems that range from 10 to 30 volts
- Lamps are hardwired with standard .180 molded bullet connectors
- Module receptacle wires with ring terminals available for retrofitting LED lamps to existing modules
- Direct pin-to-circuit board solders assure vibration resistant contacts
- Electronics completely sealed in epoxy to resist corrosion and moisture
- Low current draw, leaving more power for other vehicle requirements
- Sonically sealed lens and housing
- LEDs are less susceptible to shock and vibration
- Available in three versions - high intensity fog (red), direction indicator (yellow) and rear position (red)
- Approved to comply with ECE regulations for rear position/stop, direction indicator and rear fog functions



Part Number	Lamp Connector	Plug Side 1	Plug Side 2	Lens Material	Volts	Amps Major/Minor
45934Y	Hardwired	Hardwired	.180 Bullet	PC	12 24	0.31/0.03

LED
45 SERIES

45[®] SERIES, LED, 70 DIODES, 3"X 5" RECTANGULAR, GROMMET MOUNT

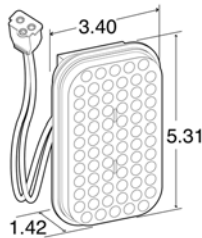
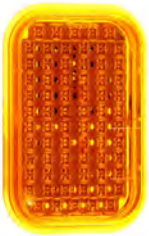

- Hardwired design
- Mounts horizontally or vertically
- Permanently affixed flange-mount version
- Standard connector makes retrofitting easy



Part Number	Lamp Connector	Plug Side 1	Plug Side 2	Lens Material	Volts	Amps Major/Minor
45251Y	Hardwired	Hardwired	Straight PL-3	PC	12	0.36/0.03
45263Y	Hardwired	Hardwired	Straight PL-3	PC	24	0.28/0.03

45[®] SERIES, LED, 70 DIODES, 3"X 5" RECTANGULAR, GROMMET MOUNT, KIT



- Hardwired design
- Mounts horizontally or vertically
- Permanently affixed flange-mount version
- Standard connector makes retrofitting easy

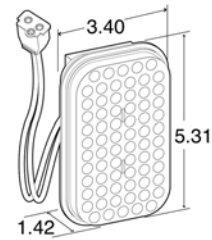

Part Number	Lamp Connector	Plug Side 1	Plug Side 2	Lens Material	Mount Color	Volts	Amps Major/Minor	Kit Includes/ Replacement Parts
45051Y	Hardwired	Hardwired	Straight PL-3	PC	Black	12	0.28/0.03	45700 grommet, 45251Y lamp
45063Y	Hardwired	Hardwired	Straight PL-3	PC	Black	24	0.28/0.03	94789 plug, 45263Y lamp

45[®] SERIES, LED, 70 DIODES, 3"X 5" RECTANGULAR, FLANGE MOUNT



- Hardwired design
- Mounts horizontally or vertically
- Permanently affixed flange-mount version
- Standard connector makes retrofitting easy

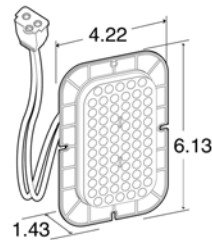

Part Number	Lamp Connector	Plug Side 1	Plug Side 2	Lens Material	Mount Color	Volts	Amps Major / Minor
45256Y	Hardwired	Hardwired	Straight PL-3	PC	Yellow	12	0.36/0.03

Keep Your Connections Safe. Don't Forget Your Dielectric Gel.

Dielectric gel protects your lights by protecting the points of contact between elements of your lighting and harness system. Our dielectric compounds prevent arcing and corrosion and keep your lights performing as they should.

You can find our dielectric products on page 498



60[®] SERIES, LED, 25 DIODES, 2"X 6" OVAL, GROMMET MOUNT

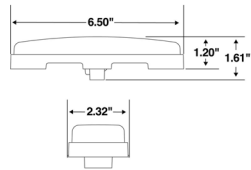

- 26 Diode for auxiliary turn lamps and 25 diode for sequential arrow lamps
- Auxiliary turn is a two-function lamp and complies with SAE 592E and 2042 on both functions
- Use part #60315Y for LED side turn applications SAE J2039
- Sequential arrow is to be used as an auxiliary lamp only and requires a 50% on time flasher, part #97231
- Not suitable for “stand alone” front or rear turn applications
- Electronics completely sealed in epoxy to resist corrosion and moisture



Part Number	Lamp Connector	Lens Material	Volts	Amps Major/Minor
60280Y	Fit 'N Forget S.S.	PC	12	0.12/0.08

60[®] SERIES, LED, 25 DIODES, 2"X 6" OVAL, GROMMET MOUNT, KIT

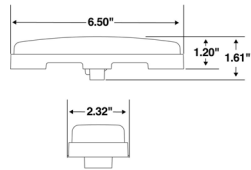

- 26 Diode for Auxiliary Turn Lamps and 25 Diode for Sequential Arrow Lamps
- Auxiliary turn is a two-function lamp and complies with SAE 592E and 2042 on both functions
- Use part #60315Y for LED side turn applications SAE J2039
- Sequential arrow is to be used as an auxiliary lamp only and requires a 50% on time flasher, part #97231
- Not suitable for “stand alone” front or rear turn applications
- Electronics completely sealed in epoxy to resist corrosion and moisture



Part Number	Lamp Connector	Plug Side 1	Plug Side 2	Lens Material	Mount Color	Volts	Amps Major/Minor	Kit Includes/ Replacement Parts
60080Y	Fit 'N Forget S.S.	Fit 'N Forget S.S.	Straight Female PL-3	PC	Black	12	0.12/0.08	60700 grommet, 94706 plug, 60280Y lamp

Keep Your Connections Safe. Don't Forget Your Dielectric Gel.

Dielectric gel protects your lights by protecting the points of contact between elements of your lighting and harness system. Our dielectric compounds prevent arcing and corrosion and keep your lights performing as they should.

You can find our dielectric products on page 498



60[®] SERIES, LED, 25 DIODES, 2" X 6" OVAL, FLANGE MOUNT



- 26 Diode for Auxiliary Turn Lamps and 25 Diode for Sequential Arrow Lamps
- Auxiliary turn is a two-function lamp and complies with SAE 592E and 2042 on both functions
- Use part #60315Y for LED side turn applications SAE J2039
- Sequential arrow is to be used as an auxiliary lamp only and requires a 50% on time flasher, part #97231
- Not suitable for "stand alone" front or rear turn applications
- Electronics completely sealed in epoxy to resist corrosion and moisture

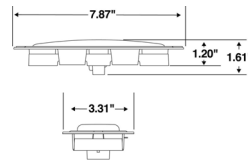

Part Number	Lamp Connector	Lens Material	Mount Color	Volts	Amps Major / Minor
60282Y	Fit 'N Forget S.S.	PC	Gray	12	0.12/0.08
60286Y	Fit 'N Forget S.S.	PC	Black	12	0.12/0.08

60[®] SERIES, LED, 25 DIODES, 2" X 6" OVAL, FLANGE MOUNT, KIT



- 26 Diode for Auxiliary Turn Lamps and 25 Diode for Sequential Arrow Lamps
- Auxiliary turn is a two-function lamp and complies with SAE 592E and 2042 on both functions
- Use part #60315Y for LED side turn applications SAE J2039
- Sequential arrow is to be used as an auxiliary lamp only and requires a 50% on time flasher, part #97231
- Not suitable for "stand alone" front or rear turn applications
- Electronics completely sealed in epoxy to resist corrosion and moisture

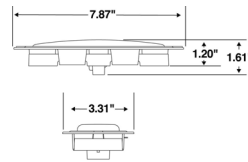

Part Number	Lamp Connector	Plug Side 1	Plug Side 2	Lens Material	Mount Color	Volts	Amps Major/Minor	Kit Includes/ Replacement Parts
60082Y	Fit 'N Forget S.S.	Fit 'N Forget S.S.	Straight Female PL-3	PC	Gray	12	0.12/0.08	94706 plug, 60282Y lamp

60[®] SERIES, LED, 26 DIODES, 2" X 6" OVAL, GROMMET MOUNT

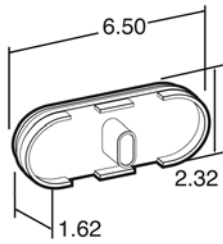

- Auxiliary turn is a two-function lamp and complies with SAE 592E and 2042 on both functions
- Use part #60315Y for LED side turn applications SAE J2039
- Sequential arrow is to be used as an auxiliary lamp only and requires a 50% on time flasher, part #97231
- Not suitable for “stand alone” front or rear turn applications
- Electronics completely sealed in epoxy to resist corrosion and moisture



Part Number	Lamp Connector	Lens Material	Volts	Amps Major/Minor
60255Y	Fit 'N Forget S.S.	PC	24	0.18/0.06
60275Y	Fit 'N Forget S.S.	PC	12	0.42/0.1
60891Y	Fit 'N Forget S.S.	AC	12	0.42/0.1

60[®] SERIES, LED, 26 DIODES, 2" X 6" OVAL, GROMMET MOUNT, KIT

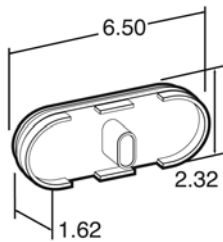

- Auxiliary turn is a two-function lamp and complies with SAE 592E and 2042 on both functions
- Use part #60315Y for LED side turn applications SAE J2039
- Sequential arrow is to be used as an auxiliary lamp only and requires a 50% on time flasher, part #97231
- Not suitable for “stand alone” front or rear turn applications
- Electronics completely sealed in epoxy to resist corrosion and moisture



Part Number	Lamp Connector	Plug Side 1	Plug Side 2	Lens Material	Mount Color	Volts	Amps Major/Minor	Kit Includes/ Replacement Parts
60075Y	Fit 'N Forget S.S.	Fit 'N Forget S.S.	Straight Female PL-3	PC	Black	12	0.42/0.1	60700 grommet, 94706 plug, 60275Y lamp,

LED

60 SERIES

LED

60 SERIES

60[®] SERIES, LED, 26 DIODES, 2"X 6" OVAL, FLANGE MOUNT



- Auxiliary turn is a two-function lamp and complies with SAE 592E and 2042 on both functions
- Not suitable for "stand alone" front or rear turn applications
- Electronics completely sealed in epoxy to resist corrosion and moisture

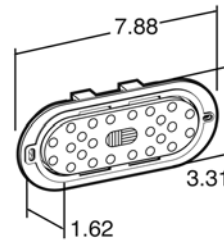

Part Number	Lamp Connector	Lens Material	Mount Color	Volts	Amps Major / Minor
60272Y	Fit 'N Forget S.S.	PC	Gray	12	0.42/0.1
60276Y	Fit 'N Forget S.S.	PC	Black	12	0.42/0.1
60872Y	Fit 'N Forget S.S.	AC	Gray	12	0.42/0.1

LED

60 SERIES

60[®] SERIES, LED, 26 DIODES, 2"X 6" OVAL, FLANGE MOUNT, KIT



- Auxiliary turn is a two-function lamp and complies with SAE 592E and 2042 on both functions
- Use part #60315Y for LED side turn applications SAE J2039
- Sequential arrow is to be used as an auxiliary lamp only and requires a 50% on time flasher, part #97231
- Not suitable for "stand alone" front or rear turn applications
- Electronics completely sealed in epoxy to resist corrosion and moisture

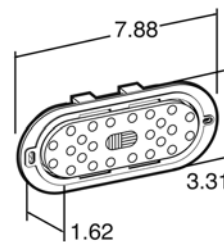

Part Number	Lamp Connector	Plug Side 1	Plug Side 2	Lens Material	Mount Color	Volts	Amps Major/Minor	Kit Includes/ Replacement Parts
60072Y	Fit 'N Forget S.S.	Fit 'N Forget S.S.	Straight Female PL-3	PC	Gray	12	0.42/0.08	94706 plug, 60272Y lamp

LED

60 SERIES

Keep Your Connections Safe. Don't Forget Your Dielectric Gel.

Dielectric gel protects your lights by protecting the points of contact between elements of your lighting and harness system. Our dielectric compounds prevent arcing and corrosion and keep your lights performing as they should.

You can find our dielectric products on page 498



SUPER 60[®], LED, 11 DIODES, 2"X 6" OVAL, GROMMET MOUNT

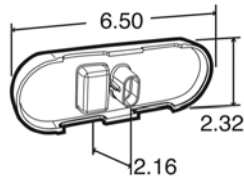

- U.S. Patent #7055996
- World's first LED side turn to surpass SAE J2039 standards in large vehicle applications
- Commonly mounted at "mid-point" on trailers or "no zone" areas on tractors
- LEDs do not have a filament, therefore are not susceptible to damage from shock and vibration
- Less current draw, resulting in increased battery and alternator life while allowing more power for other vehicle requirements
- Faster illumination offers significant safety benefit for following drivers to react quickly, resulting in an average of 3' reaction time advantage for every 10 m.p.h.



Part Number	Lamp Connector	Lens Material	Volts	Amps Major/Minor
60315Y	Fit 'N Forget S.S.	PC	12	0.52/0.08

SUPER 60[®], LED, 11 DIODES, 2"X 6" OVAL, GROMMET MOUNT, KIT

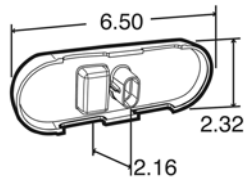

- U.S. Patent #7055996
- World's first LED side turn to surpass SAE J2039 standards in large vehicle applications
- Commonly mounted at "mid-point" on trailers or "no zone" areas on tractors
- LEDs do not have a filament, therefore are not susceptible to damage from shock and vibration
- Less current draw, resulting in increased battery and alternator life while allowing more power for other vehicle requirements
- Faster illumination offers significant safety benefit for following drivers to react quickly, resulting in an average of 3' reaction time advantage for every 10 m.p.h.



Part Number	Lamp Connector	Plug Side 1	Plug Side 2	Lens Material	Mount Color	Volts	Amps Major/Minor	Kit Includes/ Replacement Parts
60115Y	Fit 'N Forget S.S.	Fit 'N Forget S.S.	Straight Female PL-3	PC	Black	12	0.52/0.08	60700 grommet, 94706 plug, 60315Y lamp

LED

SUPER 60

LED

SUPER 60

SUPER 60[®], LED, 11 DIODES, 2"X 6" OVAL, FLANGE MOUNT



- U.S. Patent #7055996
- World's first LED side turn to surpass SAE J2039 standards in large vehicle applications
- Commonly mounted at "mid-point" on trailers or "no zone" areas on tractors
- LEDs do not have a filament, therefore are not susceptible to damage from shock and vibration
- Less current draw, resulting in increased battery and alternator life while allowing more power for other vehicle requirements
- Faster illumination offers significant safety benefit for following drivers to react quickly, resulting in an average of 3' reaction time advantage for every 10 m.p.h.

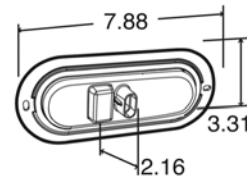

Part Number	Lamp Connector	Lens Material	Mount Color	Volts	Amps Major / Minor
60317Y	Fit 'N Forget S.S.	PC	Yellow	12	0.52/0.08

SUPER 60[®], LED, 11 DIODES, 2"X 6" OVAL, FLANGE MOUNT, KIT



- U.S. Patent #7055996
- World's first LED side turn to surpass SAE J2039 standards in large vehicle applications
- Commonly mounted at "mid-point" on trailers or "no zone" areas on tractors
- LEDs do not have a filament, therefore are not susceptible to damage from shock and vibration
- Less current draw, resulting in increased battery and alternator life while allowing more power for other vehicle requirements
- Faster illumination offers significant safety benefit for following drivers to react quickly, resulting in an average of 3' reaction time advantage for every 10 m.p.h.

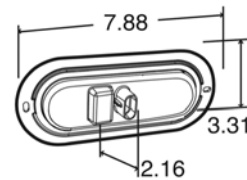

Part Number	Lamp Connector	Plug Side 1	Plug Side 2	Lens Material	Mount Color	Volts	Amps Major/Minor	Kit Includes/ Replacement Parts
60117Y	Fit 'N Forget S.S.	Fit 'N Forget S.S.	Straight Female PL-3	PC	Yellow	12	0.52/0.08	94706 plug, 60272Y lamp, 60317Y lamp

20 SERIES, 1 BULB, SIDE TURN, 2" ROUND, BRACKET MOUNT, HARDWIRED, KIT

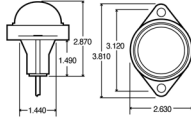

- Features snap-in lens with a 90° maximum edge visibility
- Features side turn function, with two versions also meeting marker/clearance requirements

Part Number	Lamp Connector	Plug Side 1	Plug Side 2	Lens Material	Lens Color	Mount Color	Volts	Amps Major/Minor	Kit Includes/ Replacement Parts
20301Y	Hardwired	Hardwired	Stripped End	PC	Yellow	White	12	2.1/0.5	99005Y lens
20304Y	Hardwired	Hardwired	Stripped End	PC	Yellow	White	12	2.1/0.5	99005Y lens
20309Y	Hardwired	Hardwired	.180 Bullet	PC	Yellow	Gray	12	2.1/0.5	20316Y
20310Y	Hardwired	Hardwired	Stripped End	PC	Yellow	Black	12	2.1/0.5	80604 bulb
20316Y	Hardwired	Hardwired	.180 Bullet	PC	Yellow	White	12	2.1/0.5	99005Y lens

22[®] SERIES, 1 BULB, SIDE TURN, 2"X 6" RECTANGULAR, 2 SCREW MOUNT

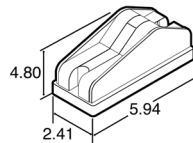

- Features dual contact marker/clearance and side turn or auxiliary turn functions
- Mounts on surface of vehicle or with "L" bracket
- Red lamp should be used for rear vehicle applications
- Yellow version exceeds SAEJ2039 side turn and marker standards

Part Number	Lamp Connector	Lens Material	Lens Color	Volts	Amps Major/Minor	Includes
22006R	PL-3	PC	Red	12	2.1/0.49	gasket
22006Y	PL-3	PC	Yellow	12	2.1/0.49	gasket
22016Y	PL-3	PC	Yellow	12	2.1/0.49	black base
22202R	PL-3	PC	Red	12	2.1/0.49	
22202Y	PL-3	PC	Yellow	12	2.1/0.49	

22[®] SERIES, 1 BULB, SIDE TURN, 2"X 6" RECTANGULAR, 2 SCREW MOUNT, KIT

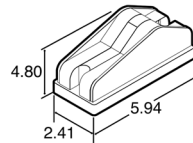

- Features dual contact marker/clearance and side turn or auxiliary turn functions
- Mounts on surface of vehicle or with "L" bracket

Part Number	Lamp Connector	Plug Side 1	Plug Side 2	Lens Material	Lens Color	Volts	Amps Major/Minor	Kit Includes/ Replacement Parts
22002R	PL-3	Right Angle PL-3	Stripped End/ Ring Terminal	PC	Red	12	2.1/0.49	22202R light, 94993 plug
22002Y	PL-3	Right Angle PL-3	Stripped End/ Ring Terminal	PC	Yellow	12	2.1/0.49	22202Y light, 94993 plug
22004R	PL-3	Right Angle PL-3	Stripped End/ Ring Terminal	PC	Red	12	2.1/0.49	22006R light, 94993 plug
22004Y	PL-3	Right Angle PL-3	Stripped End/ Ring Terminal	PC	Yellow	12	2.1/0.49	22006Y light, 94993 plug

INCANDESCENT

20 SERIES

INCANDESCENT

22 SERIES

INCANDESCENT

22 SERIES

40[®] SERIES, 2 BULB, AUXILIARY, 7"X 13" RECTANGULAR, BRACKET MOUNT



- Features large outer lens for greater visibility
- Includes slotted bracket for ease of installation and adjustment
- Available with enclosed housing for extra protection
- Use part numbers 40812 and 40830 for LED versions

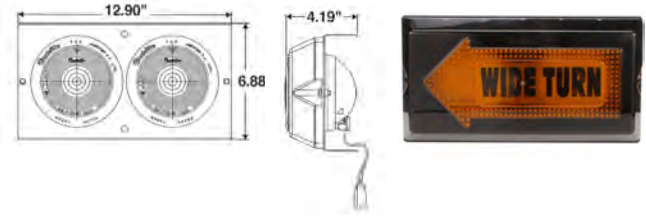

Part Number	Position	Lamp Connector	Plug Side 1	Plug Side 2	Lens Material	Lens Color	Mount Color	Volts	Amps Major/Minor
40802	LH	PL-3	Right Angle PL-3	Straight Female PL-3	PC	Yellow	Black	12	2.1/0.5
40803	RH	PL-3	Right Angle PL-3	Straight Female PL-3	PC	Yellow	Black	12	2.1/0.5
40804	LH	PL-2	PL-2	Ring Terminal	PC	Yellow	Black	12	2.1/0.5
40805	RH	PL-2	PL-2	Ring Terminal	PC	Yellow	Black	12	2.1/0.5

INCANDESCENT

40 SERIES

SUPER 40[®], 1 BULB, REAR TURN, 4" ROUND, GROMMET MOUNT



- Uses standard mounting holes and accessories
- Flush mount grommets are designed for mounting in a 4-1/2" hole
- Uniquely designed shock-mount extends lamp life
- Uses standard mounting holes and accessories
- Upgrade to Truck-Lite LED lighting systems using Super 44 Products



Part Number	Lamp Connector	Lens Material	Lens Color	Volts	Amps Major/Minor
40241R	PL-3	PC	Red	12	2.1/0.5
40241Y	PL-3	PC	Yellow	12	2.1/0.5

INCANDESCENT

SUPER 40

SUPER 40[®], 1 BULB, REAR/FRONT TURN, 4" ROUND, GROMMET MOUNT, KIT



- Uses standard mounting holes and accessories
- Flush mount grommets are designed for mounting in a 4-1/2" hole
- Uniquely designed shock-mount extends lamp life
- Uses standard mounting holes and accessories
- Upgrade to Truck-Lite LED lighting systems using Super 44 Products



Part Number	Lamp Connector	Lens Material	Lens Color	Mount Color	Volts	Amps Major/Minor	Kit Includes/ Replacement Parts
40041Y	PL-3	PC	Yellow	Black	12	2.1/0.5	40241Y lamp, 40700 grommet, 94992 plug

INCANDESCENT

SUPER 40

45[®] SERIES, 1 BULB, REAR TURN, 3"X 5" RECTANGULAR, GROMMET MOUNT, KIT

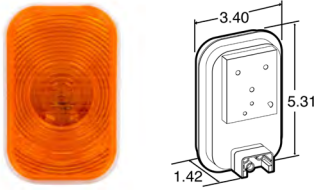

- Direct replacement for approved lamps on United States Postal Service L.L.V. (Long Life Vehicle)
- Designed for mounting on a 7 - 11 degree rollback from the vertical plane
- Three versions, each features turn and hazard functions, stop and tail functions, or back-up functions



Part Number	Lamp Connector	Plug Side 1	Plug Side 2	Lens Material	Lens Color	Mount Color	Volts	Amps Major/Minor
45021Y	PL-3	Right Angle PL-3	Packard Connector	PC	Yellow	Black	12	2.1/0.58

SUPER 45[®], 1 BULB, REAR TURN, 3"X 5" RECTANGULAR, GROMMET MOUNT, KIT



- Heavy duty bulb for longer life
- Mount horizontally or vertically
- Upgrade to Truck-Lite LED Lighting Systems using 45 Series Products



Part Number	Lamp Connector	Plug Side 1	Plug Side 2	Lens Material	Lens Color	Mount Color	Volts	Amps Major/Minor
45001R	PL-2	Right Angle PL-2	Stripped End/Ring Terminal	PC	Red	Black	12	2.1/0.58
45001Y	PL-2	Right Angle PL-2	Stripped End/Ring Terminal	PC	Yellow	Black	12	2.1/0.58

60[®] SERIES, 1 BULB, SIDE TURN, 2"X 6" OVAL, GROMMET MOUNT

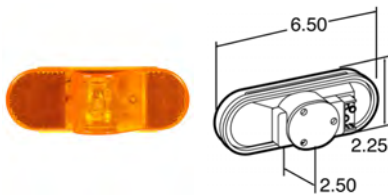

- Features side indicator, marker/clearance and reflector functions
- Narrow width facilitates horizontal mounting
- Red lamp should be used only for rear vehicle applications
- Meets SAE J2039 recommendation for side turn signal
- Upgrade to Truck-Lite LED lighting systems using Super 60 LED products



Part Number	Lamp Connector	Lens Material	Lens Color	Volts	Amps Major/Minor
60215Y	PL-3	PC	Yellow	12	2.1/0.49
60217Y	PL-3	PC	Yellow	24	1/0.36

INCANDESCENT

45 SERIES

INCANDESCENT

SUPER 45

INCANDESCENT

60 SERIES

60[®] SERIES, 1 BULB, SIDE TURN, 2"X 6" OVAL, GROMMET MOUNT, KIT



- Features side indicator, marker/clearance and reflector functions
- Narrow width facilitates horizontal mounting
- Red lamp should be used only for rear vehicle applications
- Meets SAE J2039 recommendation for side turn signal
- Upgrade to Truck-Lite LED lighting systems using Super 60 LED products

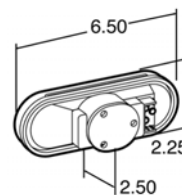

Part Number	Lamp Connector	Plug Side 1	Plug Side 2	Lens Material	Lens Color	Mount Color	Volts	Amps Major/Minor	Kit Includes/ Replacement Parts
60015R	PL-3	Right Angle PL-3	Stripped End/ Ring Terminal	PC	Red	Black	12	2.1/0.49	60215R, 94993 plug, 60700 grommet
60015Y	PL-3	Right Angle PL-3	Stripped End/ Ring Terminal	PC	Yellow	Black	12	2.1/0.49	60215Y, 94993 plug, 60700 grommet

INCANDESCENT

60 SERIES

60[®] SERIES, 1 BULB, REAR TURN, 2"X 6" OVAL, GROMMET MOUNT, KIT



- Features side indicator, marker/clearance and reflector functions
- Narrow width facilitates horizontal mounting
- Red lamp should be used only for rear vehicle applications
- Meets SAE J2039 recommendation for side turn signal
- Upgrade to Truck-Lite LED lighting systems using Super 60 LED products

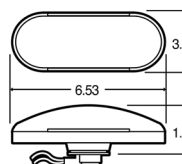

Part Number	Lamp Connector	Plug Side 1	Plug Side 2	Lens Material	Lens Color	Mount Color	Volts	Amps Major/Minor
60344R	Socket Assembly	Socket Assembly	Stripped End/ Ring Terminal	PC	Red	Black	12	2.1/0.59
60344Y	Socket Assembly	Socket Assembly	Stripped End/ Ring Terminal	PC	Yellow	Black	12	2.1/0.59

INCANDESCENT

60 SERIES

SUPER 60[®], 1 BULB, REAR TURN, 2"X 6" OVAL, GROMMET MOUNT



- Mounts horizontally or vertically
- Upgrade to Truck-Lite LED lighting systems using 60 Series LED products

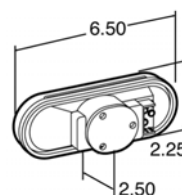

Part Number	Lamp Connector	Lens Material	Lens Color	Volts	Amps Major/Minor
60201R	PL-3	PC	Red	12	2.1/0.49
60201Y	PL-3	PC	Yellow	12	2.1/0.49

INCANDESCENT

SUPER 60

SUPER 60®, 1 BULB, AUXILIARY, 2"X 6" OVAL, GROMMET MOUNT, KIT

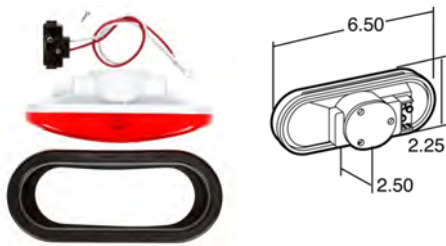

- Features side indicator, marker/clearance and reflector functions
- Narrow width facilitates horizontal mounting
- Red lamp should be used only for rear vehicle applications
- Meets SAE J2039 recommendation for side turn signal
- Upgrade to Truck-Lite LED lighting systems using Super 60 LED products



Part Number	Lamp Connector	Plug Side 1	Plug Side 2	Lens Material	Lens Color	Mount Color	Volts	Amps Major/Minor	Kit Includes/ Replacement Parts
60001R	PL-2	Right Angle PL-2	Stripped End/ Ring Terminal	PC	Red	Black	12	2.1/0.49	60201R, 94992 plug, 60700 grommet
60001Y	PL-2	Right Angle PL-2	Stripped End/ Ring Terminal	PC	Yellow	Black	12	2.1/0.49	60201Y, 94992 plug, 60700 grommet

SIGNAL-STAT, 1 BULB, REAR TURN, 6" ROUND, 4 SCREW MOUNT

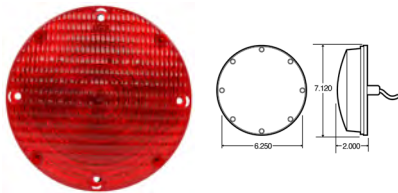

- Requires a 1" diameter hole, 1" deep
- Popular lamp on buses and emergency vehicles
- Replaces Signal-Stat 6505/A



Part Number	Lamp Connector	Plug Side 1	Plug Side 2	Lens Material	Lens Color	Volts	Amps Major/Minor
6503	Hardwired	Hardwired	Stripped End	Acrylic	Red	12	2.1/0.17

SIGNAL-STAT, 1 BULB, AUXILIARY, 2"X 6" OVAL, 2 SCREW MOUNT

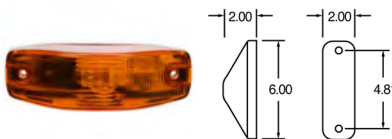

- Red for supplementary stop light or turn signal
- Yellow for side turn signal and marker lamp
- Exceeds requirements for mid-trailer turn signal lamps
- For Navistar #1677711C91 replacement use Signal Stat #4091A



Part Number	Lamp Connector	Lens Material	Lens Color	Volts	Amps Major/Minor
4091	Female TA-1415	PC	Red	12	2.1/0.5
4091A	Female TA-1415	PC	Yellow	12	2.1/0.5
4093	Female TA-1415	PC	Red	12	2.1/0.5
4093A	Female TA-1415	PC	Yellow	12	2.1/0.5

INCANDESCENT

SUPER 60

INCANDESCENT

SIGNAL-STAT

INCANDESCENT

SIGNAL-STAT

SIGNAL-STAT, 1 BULB, AUXILIARY, 2"X 6" OVAL, 2 SCREW MOUNT, KIT



- Red for supplementary stop light or turn signal
- Yellow for side turn signal and marker lamp
- Exceeds requirements for mid-trailer turn signal lamps
- For Navistar #1677711C91 replacement use Signal Stat #4091A

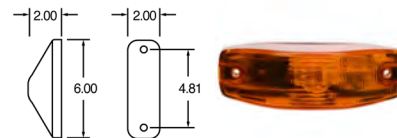

Part Number	Lamp Connector	Plug Side 1	Plug Side 2	Lens Material	Lens Color	Volts	Amps Major/Minor	Kit Includes/ Replacement Parts
4094	Female TA-1415	Right Angle PL-3	.180 Bullet Ring Terminal	PC	Red	12	2.1/0.5	SS4091 light, 9463 plug
4094A	Female TA-1415	Right Angle PL-3	.180 Bullet Ring Terminal	PC	Yellow	12	2.1/0.5	SS4091A light, 9463 plug
4095	Female TA-1415	Right Angle PL-3	.180 Bullet Ring Terminal	PC	Red	12	2.1/0.5	SS4093 light, 9463 plug
4095A	Female TA-1415	Right Angle PL-3	.180 Bullet/ Ring Terminal	PC	Yellow	12	2.1/0.5	SS4093 light, 9463 plug

SIGNAL-STAT, 1 BULB, AUXILIARY, 7"X 7" SQUARE, 2 SCREW MOUNT

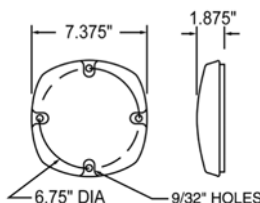

ARROW LENS

- Popular school bus signal lamps
- Rimless lens construction
- Positive seal prevents leaking and eliminates cracked lenses
- Double-optic lens covers black enameled steel housing

Part Number	Lamp Connector	Plug Side 1	Plug Side 2	Lens Material	Lens Color	Volts	Amps Major/Minor	Arrow Lens
6500	Hardwired	Hardwired	Stripped End	AC	Red	12	2.1/0.5	No
6500A	Hardwired	Hardwired	Stripped End	AC	Amber	12	2.1/0.5	No
6501	Hardwired	Hardwired	Stripped End	AC	Red	12	2.1/0.5	Yes
6501A	Hardwired	Hardwired	Stripped End	AC	Amber	12	2.1/0.5	Yes
6503A	Hardwired	Hardwired	Stripped End	AC	Amber	12	2.1/0.5	No

ROUND, 1 BULB, REAR TURN, 4" ROUND, FLANGE MOUNT



- Flush mount lamp with recessed lens
- Stainless steel retaining ring holds lens in place
- Part #81301R shown above
- Upgrade to Truck-Lite LED lighting systems using Super 44 Rear Turn Products



Part Number	Lamp Connector	Plug Side 1	Plug Side 2	Lens Material	Lens Color	Mount Color	Volts	Amps Major/Minor
81300R	Hardwired	Hardwired	Blunt Cut	PC	Red	Black	12	2.1/0.5
81300Y	Hardwired	Hardwired	Blunt Cut	PC	Yellow	Black	12	2.1/0.5

OVAL, 1 BULB, SIDE TURN, 2"X 6" OVAL, GROMMET MOUNT

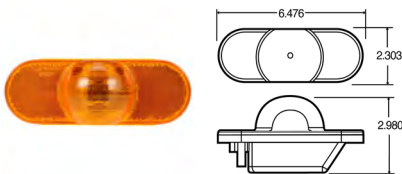

- Male pin connections
- Features side indicator, marker/clearance and reflector functions
- Narrow width facilitates horizontal mounting
- Meets SAE J2039 recommendation for side turn signal
- Replaces Grote #52533
- Upgrade to Truck-Lite LED lighting systems using Super 60 LED lamps



Part Number	Lamp Connector	Lens Material	Lens Color	Volts	Amps Major/Minor
69202Y	PL-3	PC	Yellow	12	2.1/0.5

OVAL, 1 BULB, SIDE TURN, 2"X 6" OVAL, GROMMET MOUNT, KIT

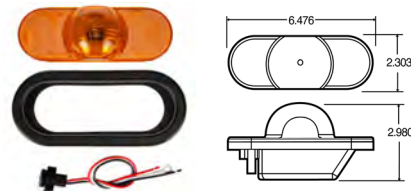

- Male pin connections
- Features side indicator, marker/clearance and reflector functions
- Narrow width facilitates horizontal mounting
- Meets SAE J2039 recommendation for side turn signal
- Replaces Grote #52533
- Upgrade to Truck-Lite LED lighting systems using Super 60 LED lamps



Part Number	Lamp Connector	Plug Side 1	Plug Side 2	Lens Material	Lens Color	Mount Color	Volts	Amps Major/Minor	Kit Includes/ Replacement Parts
69002Y	PL-3	Female PL-3	Stripped End/ Ring Terminal	PC	Yellow	Black	12	2.1/0.5	69202Y lamp, 96107 plug, 60700 grommet

INCANDESCENT

ROUND 1 BULB

INCANDESCENT

OVAL 1 BULB

INCANDESCENT

OVAL 1 BULB

RECTANGULAR, 1 BULB, REAR TURN, 4"X 6" RECTANGULAR, 4 SCREW MOUNT, SOCKET ASSEMBLY



- Polycarbonate lens and housing are sealed
- Bulb socket cams-in for ease of repair/ replacement (sold separately)
- Recess mounts using two screws at 3.0" centers and two screws at 4.2" centers

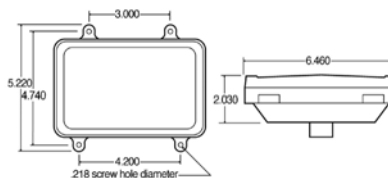

Part Number	Lamp Connector	Lens Material	Lens Color
7097	Socket Assembly	PC	Yellow

INCANDESCENT

RECTANGULAR 1 BULB

Looking for even more product information?

Visit truck-lite.com



Powerful Search Function



360° Product Images



Easy-To-Find Replacement Parts

SUPER 44[®], LED, 6 DIODES, 4" ROUND, GROMMET MOUNT

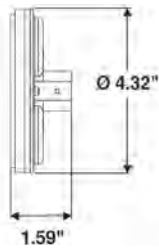

- Offers the same safety and low maintenance benefits of existing F/P/T lights with fewer diodes
- Uses less current draw, resulting in increased battery & alternator life while allowing more power for other vehicle requirements
- LEDs do not have a filament, therefore are not susceptible to damage from shock and vibration
- Flange mounts are permanently affixed to light
- Designed to comply with FMVSS 108



Part Number	Lamp Connection	Lens Material	Lens Color	Volts	Amps Major/Minor	Diamond Shell
44294Y	Fit 'N Forget S.S.	PC	Yellow	12	0.03/0.59	No
44291Y	Fit 'N Forget S.S.	AC	Yellow	12	0.03/0.59	Yes

SUPER 44[®], LED, 6 DIODES, 4" ROUND, GROMMET MOUNT, KIT

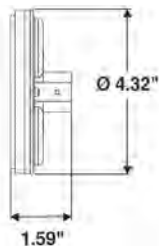

- Offers the same safety and low maintenance benefits of existing F/P/T lights with fewer diodes
- Uses less current draw, resulting in increased battery & alternator life while allowing more power for other vehicle requirements
- LEDs do not have a filament, therefore are not susceptible to damage from shock and vibration
- Flange mounts are permanently affixed to light
- Designed to comply with FMVSS 108



Part Number	Lamp Connection	Plug Side 1	Plug Side 2	Lens Material	Lens Color	Mount/Trim Color	Volts	Amps Major/Minor	Diamond Shell	Kit Includes/Replacement Parts
44094Y	Fit 'N Forget S.S.	Fit 'N Forget S.S.	Female PL-3	PC	Yellow	Black	12	0.03/0.59	No	44294Y light, 40700 grommet, 94706 plug
44091Y	Fit 'N Forget S.S.	Fit 'N Forget S.S.	Female PL-3	AC	Yellow	Black	12	0.03/0.59	Yes	44291Y light, 40700 grommet, 94760 plug

Keep Your Connections Safe. Don't Forget Your Dielectric Gel.

Dielectric gel protects your lights by protecting the points of contact between elements of your lighting and harness system. Our dielectric compounds prevent arcing and corrosion and keep your lights performing as they should.

You can find our dielectric products on page 498



SUPER 44[®], LED, 6 DIODES, 4" ROUND, FLANGE MOUNT



- Offers the same safety and low maintenance benefits of existing F/P/T lights with fewer diodes
- Uses less current draw, resulting in increased battery & alternator life while allowing more power for other vehicle requirements
- LEDs do not have a filament, therefore are not susceptible to damage from shock and vibration
- Flange mounts are permanently affixed to light
- Designed to comply with FMVSS 108

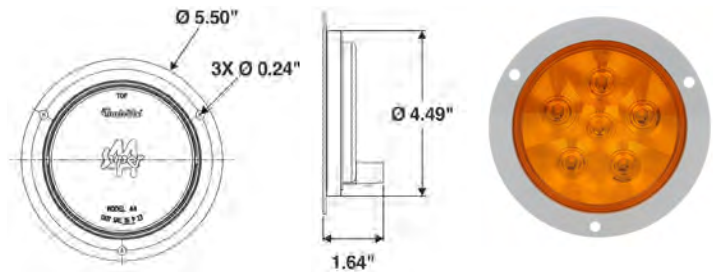

Part Number	Lamp Connection	Lens Material	Lens Color	Mount/Trim Color	Volts	Amps Major/Minor	Diamond Shell
44292Y	Fit 'N Forget S.S.	PC	Yellow	Black	12	0.03/0.59	No
44293Y	Fit 'N Forget S.S.	PC	Yellow	White	12	0.03/0.59	No
44295Y	Fit 'N Forget S.S.	PC	Yellow	Gray	12	0.03/0.59	No

SUPER 44[®], LED, 6 DIODES, 4" ROUND, FLANGE MOUNT, KIT



- Offers the same safety and low maintenance benefits of existing F/P/T lights with fewer diodes
- Uses less current draw, resulting in increased battery & alternator life while allowing more power for other vehicle requirements
- LEDs do not have a filament, therefore are not susceptible to damage from shock and vibration
- Flange mounts are permanently affixed to light
- Designed to comply with FMVSS 108

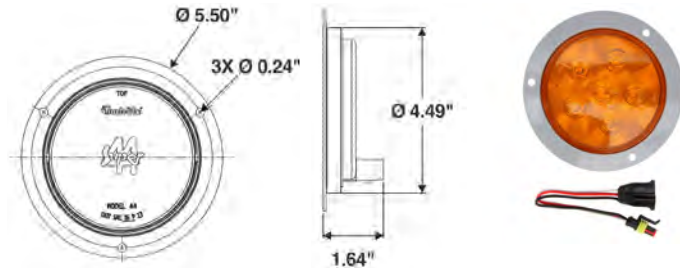

Part Number	Lamp Connection	Plug Side 1	Plug Side 2	Lens Material	Lens Color	Mount/Trim Color	Volts	Amps Major/Minor	Diamond Shell	Kit Includes/Replacement Parts
44092Y	Fit 'N Forget S.S.	Fit 'N Forget S.S.	Female PL-3	PC	Yellow	Black	12	0.03/0.59	No	44292Y light, 94706 plug
44093Y	Fit 'N Forget S.S.	Fit 'N Forget S.S.	Female PL-3	PC	Yellow	White	12	0.03/0.59	No	44293Y light, 94706 plug
44095Y	Fit 'N Forget S.S.	Fit 'N Forget S.S.	Female PL-3	PC	Yellow	Gray	12	0.03/0.59	No	44295Y light, 94706 plug

SUPER 44® , LED, 60 DIODES, 4" ROUND, GROMMET MOUNT

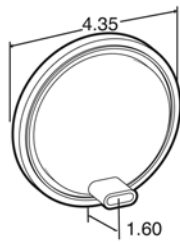

- LEDs do not have a filament, therefore are not susceptible to damage from shock and vibration
- Less current draw, resulting in increased battery and alternator life while allowing more power for other vehicle requirements
- Front, Park and Turn lamps meet stringent SAE and NHTSA requirements



Part Number	Lamp Connection	Lens Material	Lens Color	Mount/Trim Color	Volts	Amps Major/Minor	Diamond Shell
44203Y	Fit 'N Forget S.S.	PC	Yellow		12	0.1/0.75	No
44871Y	Fit 'N Forget S.S.	AC	Yellow		12	0.1/0.75	Yes

SUPER 44® , LED, 60 DIODES, 4" ROUND, GROMMET MOUNT, KIT

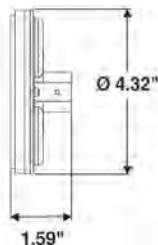

- LEDs do not have a filament, therefore are not susceptible to damage from shock and vibration
- Less current draw, resulting in increased battery and alternator life while allowing more power for other vehicle requirements
- Front, Park and Turn lamps meet stringent SAE and NHTSA requirements



Part Number	Lamp Connection	Plug Side 1	Plug Side 2	Lens Material	Lens Color	Mount/Trim Color	Volts	Amps Major/Minor	Diamond Shell	Kit Includes/Replacement Parts
44003Y	Fit 'N Forget S.S.	Fit 'N Forget S.S.	Straight Female PL-3	PC	Yellow	Black	12	0.1/0.75	No	44203Y light, 94706 plug, 40700 grommet
44071Y	Fit 'N Forget S.S.	Fit 'N Forget S.S.	Straight Female PL-3	AC	Yellow	Black	12	0.1/0.75	Yes	44871Y light, 94706 plug, 40700 grommet

Keep Your Connections Safe. Don't Forget Your Dielectric Gel.

Dielectric gel protects your lights by protecting the points of contact between elements of your lighting and harness system. Our dielectric compounds prevent arcing and corrosion and keep your lights performing as they should.

You can find our dielectric products on page 498



SUPER 44[®], LED, 60 DIODES, 4" ROUND, FLANGE MOUNT



- LEDs do not have a filament, therefore are not susceptible to damage from shock and vibration
- Less current draw, resulting in increased battery and alternator life while allowing more power for other vehicle requirements
- Front, Park and Turn lamps meet stringent SAE and NHTSA requirements



Part Number	Lamp Connection	Lens Material	Lens Color	Mount/Trim Color	Volts	Amps Major/Minor	Diamond Shell
44223Y	Fit 'N Forget S.S.	PC	Yellow	Gray	12	0.1/0.75	No
44224Y	Fit 'N Forget S.S.	PC	Yellow	Black	12	0.1/0.75	No
44233Y	Fit 'N Forget S.S.	PC	Yellow	White	12	0.1/0.75	No
44877Y	Fit 'N Forget S.S.	AC	Yellow	Gray	12	0.1/0.75	Yes
44878Y	Fit 'N Forget S.S.	AC	Yellow	Black	12	0.1/0.75	Yes

SUPER 44[®], LED, 6 DIODES, 4" ROUND, FLANGE MOUNT, KIT



- LEDs do not have a filament, therefore are not susceptible to damage from shock and vibration
- Less current draw, resulting in increased battery and alternator life while allowing more power for other vehicle requirements
- Front, Park and Turn lamps meet stringent SAE and NHTSA requirements



Part Number	Lamp Connection	Plug Side 1	Plug Side 2	Lens Material	Lens Color	Mount/Trim Color	Volts	Amps Major/Minor	Diamond Shell	Kit Includes/Replacement Parts
44023Y	Fit 'N Forget S.S.	Fit 'N Forget S.S.	Straight Female PL-3	PC	Yellow	Gray	12	0.1/0.75	No	44223Y light, 94706 plug
44024Y	Fit 'N Forget S.S.	Fit 'N Forget S.S.	Straight Female PL-3	PC	Yellow	Black	12	0.1/0.75	No	44224Y light, 94706 plug

60[®] SERIES, LED, 44 DIODES, 2" X 6" OVAL, GROMMET MOUNT

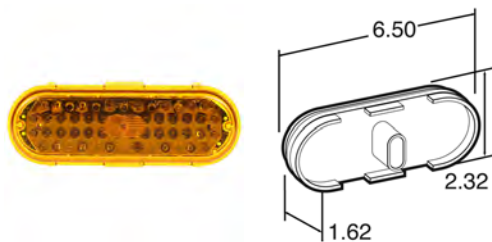

- Faster illumination offers significant safety benefit for following drivers to react quickly, resulting in an average of 3' reaction time advantage for every 10 m.p.h.
- Meets stringent Front, Park and Turn requirements
- LEDs do not have a filament, therefore are not susceptible to damage from shock and vibration
- Less current draw, resulting in increased battery and alternator life while allowing more power for other vehicle requirements



Part Number	Lamp Connection	Lens Material	Lens Color	Volts	Amps Major/Minor	Diamond Shell
60290Y	Fit 'N Forget S.S.	PC	Yellow	12	0.55 / 0.08	No
60892Y	Fit 'N Forget S.S.	AC	Yellow	12	0.55 / 0.08	Yes

60[®] SERIES, LED, 44 DIODES, 2" X 6" OVAL, GROMMET MOUNT, KIT



- Faster illumination offers significant safety benefit for following drivers to react more quickly, resulting in an average of 3' reaction time advantage for every 10 m.p.h.
- Meets stringent Front, Park and Turn requirements
- LEDs do not have a filament, therefore are not susceptible to damage from shock and vibration
- Less current draw, resulting in increased battery and alternator life while allowing more power for other vehicle requirements



Part Number	Lamp Connection	Plug Side 1	Plug Side 2	Lens Material	Lens Color	Mount/Trim Color	Volts	Amps Major/Minor	Diamond Shell	Kit Includes/Replacement Parts
60094Y	Fit 'N Forget S.S.	Fit 'N Forget S.S.	Straight Female PL-3	PC	Yellow	Black	12	0.55 / 0.08	No	60290Y light, 94706 plug, 60700 grommet
60074Y	Fit 'N Forget S.S.	Fit 'N Forget S.S.	Packard Connector 12015793	PC	Yellow	Black	12	0.55 / 0.08	No	60701 grommet

60[®] SERIES, LED, 44 DIODES, 2" X 6" OVAL, FLANGE MOUNT



- Faster illumination offers significant safety benefit for following drivers to react more quickly, resulting in an average of 3' reaction time advantage for every 10 m.p.h.
- Meets stringent Front, Park and Turn requirements
- LEDs do not have a filament, therefore are not susceptible to damage from shock and vibration
- Less current draw, resulting in increased battery and alternator life while allowing more power for other vehicle requirements

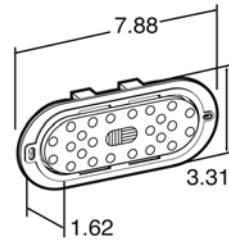

Part Number	Lamp Connection	Lens Material	Lens Color	Mount/Trim Color	Volts	Amps Major/Minor	Diamond Shell
60291Y	Fit 'N Forget S.S.	PC	Yellow	Gray	12	0.55 / 0.09	No
60292Y	Fit 'N Forget S.S.	PC	Yellow	Black	12	0.55 / 0.09	No

60[®] SERIES, LED, 44 DIODES, 2" X 6" OVAL, FLANGE MOUNT, KIT



- Faster illumination offers significant safety benefit for following drivers to react more quickly, resulting in an average of 3' reaction time advantage for every 10 m.p.h.
- Meets stringent Front, Park and Turn requirements
- LEDs do not have a filament, therefore are not susceptible to damage from shock and vibration
- Less current draw, resulting in increased battery and alternator life while allowing more power for other vehicle requirements

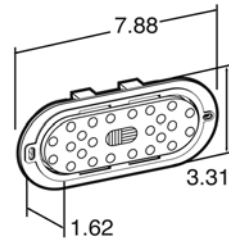

Part Number	Lamp Connection	Plug Side 1	Plug Side 2	Lens Material	Lens Color	Mount/Trim Color	Volts	Amps Major/Minor	Diamond Shell	Kit Includes/Replacement Parts
60096Y	Fit 'N Forget S.S.	Fit 'N Forget S.S.	Straight Female PL-3	PC	Yellow	Gray	12	0.55 / 0.09	No	60291Y light, 94706 plug
60097Y	Fit 'N Forget S.S.	Fit 'N Forget S.S.	Straight Female PL-3	PC	Yellow	Black	12	0.55 / 0.09	No	60292Y light, 94706 plug

91[®] SERIES, LED, 47 DIODES, 7" ROUND, 4 SCREW MOUNT

LED

SUPER 44

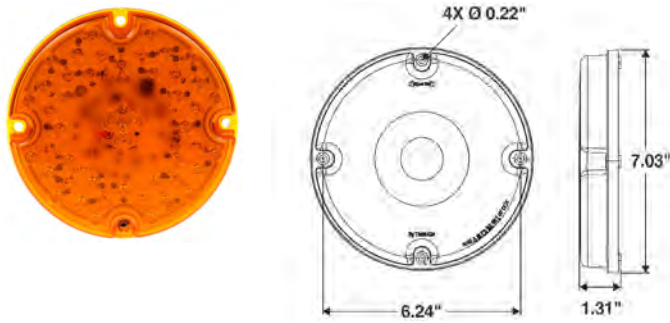

Part Number	Lamp Connection	Plug Side 1	Plug Side 2	Lens Material	Lens Color	Volts	Amps Major/Minor	Diamond Shell
91370Y	Hardwired	Hardwired	Packard Connector 12015792	AC	Yellow	12	0.65 / 0.04	No

Looking for even more product information?

Visit truck-lite.com



Powerful Search Function



360° Product Images



Easy-To-Find Replacement Parts

SIGNAL-STAT, LED, 10 DIODES, 4" ROUND, GROMMET MOUNT



- Uses standard PL-3 connector
- When properly mounted, exceeds FMVSS-P2 DOT requirements for marker/clearance performance
- Designed with impact-resistant acrylic material
- Sealed lens and housing locks moisture out
- Snap fit grommet requires no screws for installation
- LEDs do not have a filament, therefore are not susceptible to damage from shock and vibration
- Epoxy-encapsulated electronics prevents damage from moisture and corrosion
- Popular on owner/operator and show trucks

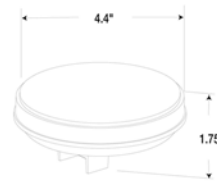

Part Number	Lamp Connection	Lens Material	Lens Color	Mount/Trim Color	Volts	Amps Major/Minor	Diamond Shell
4058A	PL-3	AC	Yellow		12	0.02/0.12	No

SIGNAL-STAT, LED, 24 DIODES, 4" ROUND, GROMMET MOUNT



- Popular on owner/operator show trucks
- Uses standard right angle connection
- Unique LED array displays a full pattern light output design
- Epoxy-encapsulated electronics prevents damage from moisture and corrosion
- Less current draw, resulting in increased battery and alternator life while allowing more power for other vehicle requirements
- LEDs do not have a filament, therefore are not susceptible to damage from shock and vibration

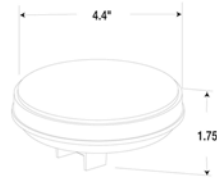

Part Number	Lamp Connection	Lens Material	Lens Color	Mount/Trim Color	Volts	Amps Major/Minor	Diamond Shell
4050A	PL-3	PC	Yellow		12	0.03/0.38	No
4051A	PL-3	PC	Clear Yellow		12	0.03/0.38	No

SIGNAL-STAT, LED, 24 DIODES, 4" ROUND, FLANGE MOUNT



- Housing and flange are molded together to form one piece
- Uses standard right angle PL-3 connection
- Designed with impact-resistant polycarbonate material
- LEDs do not have a filament, therefore are not susceptible to damage from shock and vibration
- Epoxy-encapsulated electronics prevents damage from moisture and corrosion
- When properly mounted, exceeds FMVSS DOT requirements for S/T/T and F/P/T

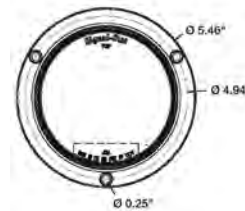

Part Number	Lamp Connection	Lens Material	Lens Color	Mount/Trim Color	Volts	Amps Major/Minor	Diamond Shell
4053A	PL-3	PC	Yellow	Gray	12	0.01/0.14	No

SIGNAL-STAT, LED, 10 DIODES, 2" X 6" OVAL, GROMMET MOUNT

LED

SIGNAL-STAT

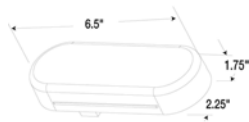

- When properly mounted, exceeds FMVSS-P2 DOT requirements for marker/clearance performance
- Designed with impact-resistant acrylic material
- Sealed lens and housing locks moisture out
- Snap fit grommet requires no screws for installation
- LEDs do not have a filament, therefore are not susceptible to shock and vibration damage major cause of failure for lamps with an incandescent bulb
- Epoxy-encapsulated electronics prevents damage from moisture and corrosion
- Popular on owner/operator and show trucks



Part Number	Lamp Connection	Lens Material	Lens Color	Volts	Amps Major/Minor	Diamond Shell
6058A	PL-3	AC	Yellow	12	0.17 / 0.02	No

SIGNAL-STAT, LED, 24 DIODES, 2" X 6" OVAL, GROMMET MOUNT

LED

SIGNAL-STAT



- Popular for owner/operator show trucks
- Uses standard right angle plug
- Unique LED array displays full pattern light output design
- Epoxy-encapsulated electronics prevents damage from moisture and corrosion



Part Number	Lamp Connection	Lens Material	Lens Color	Volts	Amps Major/Minor	Diamond Shell
6050A	PL-3	PC	Yellow	12	0.38 / 0.03	No
6051A	PL-3	PC	Clear Yellow	12	0.38 / 0.03	No

SIGNAL-STAT, LED, 24 DIODES, 2" X 6" OVAL, FLANGE MOUNT

LED

SIGNAL-STAT

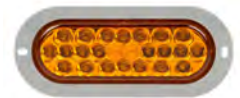

- Housing and flange are molded together to form one piece
- Uses standard right angle PL-3 connection
- Designed with impact-resistant polycarbonate material
- LEDs do not have a filament, therefore are not susceptible to shock and vibration damage major cause of failure for lamps with an incandescent bulb
- Epoxy-encapsulated electronics prevents damage from moisture and corrosion
- When properly mounted, exceeds FMVSS DOT requirements for S/T/T and F/P/T



Part Number	Lamp Connection	Lens Material	Lens Color	Mount/Trim Color	Volts	Amps Major/Minor	Diamond Shell
6053A	PL-3	PC	Yellow	Gray	12	0.26 / 0.02	No

Looking for even more product information?

Visit truck-lite.com



**Powerful Search
Function**



**360° Product
Images**



**Easy-To-Find
Replacement
Parts**

40® SERIES, INCANDESCENT, 1 BULB, 4" ROUND, GROMMET MOUNT



- Heavy-duty bulb for long-lasting life
- Uniquely designed shock mount extends lamp life
- Available with or without reflectorized lens
- Flush-mount grommets are designed for mounting in a 4 1/2" hole
- 8 square inch (illuminating) stop/turn lens area for vehicles under 80 inches wide
- Meets reflex, tail or clearance function for vehicles over 80 inches wide
- Upgrade to LED lighting systems using Truck-Lite's Super 44 series of products

Part Number	Lamp Connection	Lens Material	Lens Color	Volts	Amps Major/Minor	Housing Color
40202Y	PL-3	PC	Yellow	12	2.1 / 0.48	White
40206Y	PL-3	PC	Yellow	12	2.1 / 0.48	Clear
40209Y	PL-3	PC	Yellow	24	0.93 / 0.34	White

40® SERIES, INCANDESCENT, 1 BULB, 4" ROUND, GROMMET MOUNT, KIT



- Heavy-duty bulb for long-lasting life
- Unique-designed shock mount extends lamp life
- Available with or without reflectorized lens
- Flush-mount grommets are designed for mounting in a 4 1/2" hole
- 8 square inch (illuminating) stop/turn lens area for vehicles under 80 inches wide.
- Meets reflex, tail or clearance function for vehicles over 80 inches wide
- Upgrade to LED lighting systems using Truck-Lite's Super 44 series of products

Part Number	Lamp Connection	Plug Side 1	Plug Side 2	Lens Material	Lens Color	Mount/Trim Color	Volts	Amps Major/Minor	Kit Includes/Replacement Parts
40002Y	PL-3	Right Angle PL-3	Stripped End/Ring Terminal	PC	Yellow	Black	12	2.1 / 0.48	40202Y light, 94993 plug, 40700 grommet
40009Y	PL-3	Right Angle PL-3	Stripped End/Ring Terminal	PC	Yellow	Black	24	0.93 / 0.34	40209Y light, 94993 plug, 40700 grommet
40302Y	Socket Assembly	Socket Assembly	Stripped End/Ring Terminal	PC	Yellow	Black	12	2.1 / 0.48	99010Y light

40® SERIES, INCANDESCENT, 1 BULB, 4" ROUND, FLANGE MOUNT

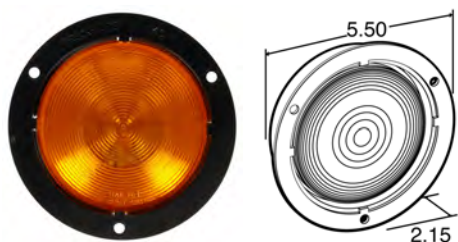

- Heavy-duty bulb for long-lasting life
- Uniquely designed shock mount extends lamp life
- Available with or without reflectorized lens
- Flush-mount grommets are designed for mounting in a 4 1/2" hole
- 8 square inch (illuminating) stop/turn lens area for vehicles under 80 inches wide
- Meets reflex, tail or clearance function for vehicles over 80 inches wide
- Upgrade to LED lighting systems using Truck-Lite's Super 44 series of products

Part Number	Lamp Connection	Lens Material	Lens Color	Mount/Trim Color	Volts	Amps Major/Minor
40233Y	PL-3	PC	Yellow	Black	12	2.1 / 0.48

INCANDESCENT

40 SERIES

INCANDESCENT

40 SERIES

INCANDESCENT

40 SERIES

40[®] ECONOMY, INCANDESCENT, 1 BULB, 4" ROUND, GROMMET MOUNT



- Grommet kit features flush mounting in a 4 1/2" hole
- Flange kits feature a high-impact plastic affixed to lamp
- 8 square inch (illuminating) stop/turn lens area for vehicles under 80 inches wide
- Meets reflex, tail or clearance function for vehicles over 80 inches wide
- Upgrade to LED lighting systems using Truck-Lite's LED 44 Series lighting products

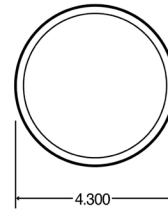

Part Number	Lamp Connection	Lens Material	Lens Color	Mount/Trim Color	Volts	Amps Major/Minor
40282Y	PL-3	PC	Yellow		12	2.1 / 0.48

INCANDESCENT

40 ECONOMY

40[®] ECONOMY, INCANDESCENT, 1 BULB, 4" ROUND, GROMMET MOUNT, KIT



- Grommet kit features flush mounting in a 4 1/2" hole
- Flange kits feature a high-impact plastic affixed to lamp
- 8 square inch (illuminating) stop/turn lens area for vehicles under 80 inches wide
- Meets reflex, tail or clearance function for vehicles over 80 inches wide
- Upgrade to LED lighting systems using Truck-Lite's LED 44 Series lighting products

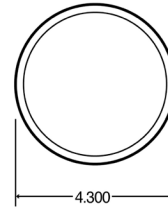

Part Number	Lamp Connection	Plug Side 1	Plug Side 2	Lens Material	Lens Color	Mount/Trim Color	Volts	Amps Major/Minor	Kit Includes/Replacement Parts
40028Y	PL-3	Right Angle PL-3	Stripped End/Ring Terminal	PC	Yellow	Black	12	2.1 / 0.48	40282Y light, 94993 plug, 40700 grommet

INCANDESCENT

40 ECONOMY

SUPER 45[®], INCANDESCENT, 1 BULB, 3"X 5" RECTANGULAR, GROMMET MOUNT

INCANDESCENT

45 SERIES

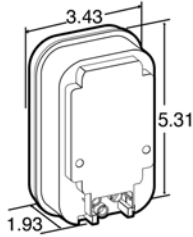

- Mount horizontally or vertically
- Heavy-duty, dual-filament cartridge bulb
- Unique shock mount absorbs shock and vibration
- Upgrade to LED lighting systems using Truck-Lite's Super 45 LED series product line



Part Number	Lamp Connection	Lens Material	Lens Color	Mount/Trim Color	Volts	Amps Major/Minor
45202Y	PL-3	PC	Yellow	Black	12	2.16 / 0.47

SUPER 45[®], INCANDESCENT, 1 BULB, 3"X 5" RECTANGULAR, GROMMET MOUNT, KIT

INCANDESCENT

45 SERIES

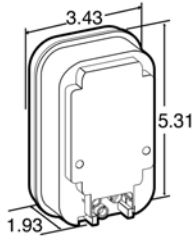

- Mount horizontally or vertically
- Heavy-duty, dual-filament cartridge bulb
- Unique shock mount absorbs shock and vibration
- Upgrade to LED lighting systems using Truck-Lite's Super 45 LED series product line



Part Number	Lamp Connection	Plug Side 1	Plug Side 2	Lens Material	Lens Color	Mount/Trim Color	Volts	Amps Major/Minor	Kit Includes/Replacement Parts
45002Y	PL-3	Right Angle PL-3	Stripped End/Ring Terminal	PC	Yellow	Black	12	2.16 / 0.47	45202Y light, 94993 plug, 45700 grommet

60[®] SERIES, INCANDESCENT, 1 BULB, 2"x 6" OVAL, GROMMET MOUNT, KIT

INCANDESCENT

60 SERIES

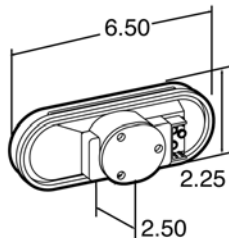

- Direct replacement for approved lamps on the United States Postal Service L.L.V (Long Life Vehicles)
- Features a heavy-duty shock-mounted bulb
- Four versions, each features center high mount stop functions, park and turn functions, rear side marker and turn functions, or front side marker and turn signal functions



Part Number	Lamp Connection	Plug Side 1	Plug Side 2	Lens Material	Lens Color	Mount/Trim Color	Volts	Amps Major/Minor	Kit Includes/Replacement Parts
60022Y	PL-3	Right Angle PL-3	Stripped End/Ring Terminal	PC	Yellow	Black	12	2.1 / 0.48	60202Y light, 60701 grommet, 94839 plug

60[®] SERIES, INCANDESCENT, 1 BULB, 2"x 6" OVAL, GROMMET MOUNT, KIT



- Lamp may be either grommet or screw mounted
- Mounts horizontally or vertically
- .250 Internal Knockout hole / 1.620 Clearance hole
- Upgrade to Truck-Lite LED Lighting Systems using 60 Series LED products

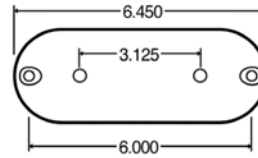

Part Number	Lamp Connection	Plug Side 1	Plug Side 2	Lens Material	Lens Color	Mount/Trim Color	Volts	Amps Major/Minor	Kit Includes/Replacement Parts
60302Y	Hardwired	Hardwired	Stripped End/Ring Terminal	PC	Yellow	Black	12	2.1 / 0.48	60781 light, 99011Y lens

INCANDESCENT

60 SERIES

60[®] SERIES, INCANDESCENT, 1 BULB, 2"x 6" OVAL, GROMMET MOUNT, KIT



- Socket assembly cams-out for ease in bulb replacement
- Mounts horizontally or vertically
- Upgrade to Truck-Lite LED Lighting Systems using Super 66 or 60 Series LED products

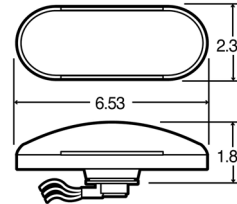

Part Number	Lamp Connection	Plug Side 1	Plug Side 2	Lens Material	Lens Color	Mount/Trim Color	Volts	Amps Major/Minor	Kit Includes/Replacement Parts
60340Y	Socket Assembly	Socket Assembly	Stripped End/Ring Terminal	PC	Yellow	Black	12	2.1 / 0.48	99184Y light, 95407 plug

INCANDESCENT

60 SERIES

SUPER 60[®], INCANDESCENT, 1 BULB, 2"x 6" OVAL, GROMMET MOUNT



- Mount horizontally or vertically
- Right angle plug assembly
- Upgrade to Truck-Lite LED lighting systems using Super 66 or 60 Series LED products

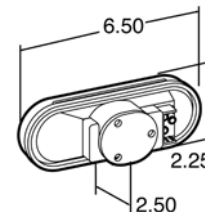

Part Number	Lamp Connection	Lens Material	Lens Color	Mount/Trim Color	Volts	Amps Major/Minor
60202Y	PL-3	PC	Yellow		12	2.1 / 0.48
60207Y	PL-3	PC	Yellow		24	0.93 / 0.34

INCANDESCENT

SUPER 60

SUPER 60®, INCANDESCENT, 1 BULB, 2"x 6" OVAL, GROMMET MOUNT

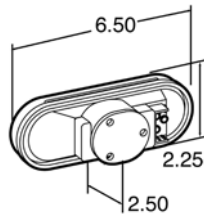

- Mount horizontally or vertically
- Right angle plug assembly
- Upgrade to Truck-Lite LED lighting systems using Super 66 or 60 Series LED products



Part Number	Lamp Connection	Plug Side 1	Plug Side 2	Lens Material	Lens Color	Mount/Trim Color	Volts	Amps Major/Minor	Kit Includes/Replacement Parts
60002Y	PL-3	Right Angle PL-3	Stripped End/Ring Terminal	PC	Yellow	Black	12	2.1 / 0.48	60202Y light, 94993 plug, 60700 grommet

60® ECONOMY, INCANDESCENT, 1 BULB, 2"x 6" OVAL, GROMMET MOUNT

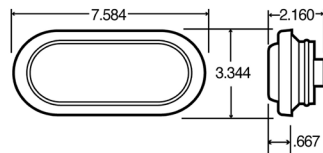

- Mount horizontally or vertically
- Contains a heavy-duty, dual filament bulb
- Upgrade to Truck-Lite LED lighting systems using Super 66 or 60 Series LED products



Part Number	Lamp Connection	Lens Material	Lens Color	Mount/Trim Color	Volts	Amps Major/Minor
60283Y	PL-3	PC	Yellow		12	2.1 / 0.48

60® ECONOMY, INCANDESCENT, 1 BULB, 2"x 6" OVAL, GROMMET MOUNT, KIT

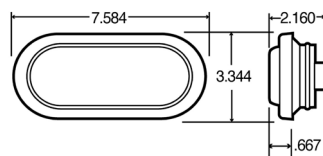

- Mount horizontally or vertically
- Contains a heavy-duty, dual-filament bulb
- Upgrade to Truck-Lite LED lighting systems using Super 66 or 60 Series LED products



Part Number	Lamp Connection	Plug Side 1	Plug Side 2	Lens Material	Lens Color	Mount/Trim Color	Volts	Amps Major/Minor	Kit Includes/Replacement Parts
60083Y	PL-3	Right Angle PL-3	Stripped End/Ring Terminal	PC	Yellow	Black	12	2.1 / 0.48	60283Y light, 94993 plug, 60700 grommet

91[®] SERIES, INCANDESCENT, 1 BULB, 7" ROUND, 4 SCREW MOUNT



- Contains a heavy-duty, shock-mount, 12 volt bulb
- Mounting gasket provides additional protection between lamp and body
- Mounts in a 5.375" hole

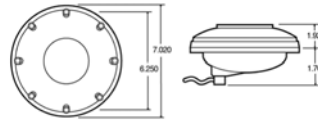

Part Number	Lamp Connection	Lens Material	Lens Color	Mount/Trim Color	Volts	Amps Major/Minor
91202Y	PL-3	PC	Yellow	Yellow	12	2.1 / 0.48
91205Y	PL-3	PC	Yellow	Yellow	24	0.93 / 0.34

INCANDESCENT

91 SERIES

91[®] SERIES, INCANDESCENT, 1 BULB, 7" ROUND, 4 SCREW MOUNT, KIT



- Contains a heavy-duty shock-mount 12 volt bulb
- Mounting gasket provides additional protection between lamp and body
- Mounts in a 5.375" hole

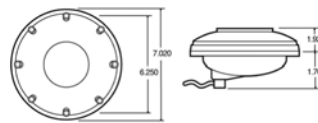

Part Number	Lamp Connection	Plug Side 1	Plug Side 2	Lens Material	Lens Color	Mount/Trim Color	Volts	Amps Major/Minor	Kit Includes/Replacement Parts
91002Y	PL-3	Right Angle PL-3	Stripped End/Ring Terminal	PC	Yellow	Yellow	12	2.1 / 0.48	91202Y light, 94993 plug
91315Y	Socket Assembly	Socket Assembly	Stripped End/Ring Terminal	PC	Yellow	Yellow	12	2.1 / 0.59	99021Y light, 95407 socket

INCANDESCENT

91 SERIES

1 BULB, 7" ROUND, 4 SCREW MOUNT

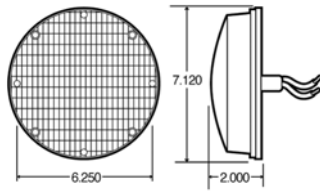

- Surface mounts with four bolts on a 6.25" bolt circle
- Requires a 1" diameter hole, 1" deep
- Popular lamp on buses and emergency vehicles
- Replaces Signal-Stat 6504



Part Number	Lamp Connection	Plug Side 1	Plug Side 2	Lens Material	Lens Color	Mount/Trim Color	Volts	Amps Major/Minor
90327Y	Hardwired	Hardwired	Blunt Cut	AC	Yellow	Yellow	12	2.1 / 0.59

1 BULB, 4"x 6" RECTANGULAR, 4 SCREW MOUNT

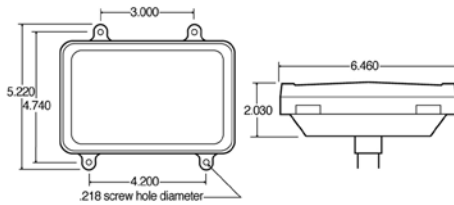

Part Number	Lamp Connection	Lens Material	Lens Color	Mount/Trim Color	Volts	Amps Major/Minor
7080	Packard Connector 6288471	PC	Yellow	Yellow	12	2.1 / 0.48

1 BULB, 6"x 10" RECTANGULAR, 4 SCREW MOUNT

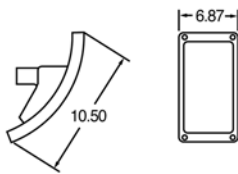
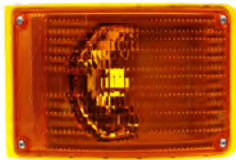

- Navistar #1677715C91
- Can be used as right or left hand housing
- Accepts rear entry bulb socket and harness assembly, not included

Part Number	Lamp Connection	Lens Material	Lens Color	Mount/Trim Color	Volts	Amps Major/Minor
4097A	Socket Assembly	PC	Yellow	Yellow	12	2.1 / 0.48

TRUCK-LITE, INCANDESCENT, 1 BULB, 4" ROUND, FLANGE MOUNT

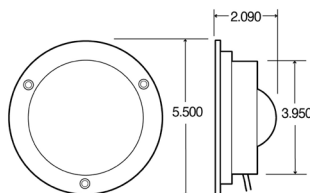

- Mounts flush to vehicle
- Retaining ring allows for easy bulb replacement
- Not intended for use as (P2) clearance
- Upgrade to Truck-Lite LED lighting systems using Super 44 products



Part Number	Lamp Connection	Plug Side 1	Plug Side 2	Lens Material	Lens Color	Mount/Trim Color	Volts	Amps Major/Minor
80302Y	Hardwired	Hardwired	Blunt Cut	AC	Yellow	Black	12	2.47 / 0.48

INCANDESCENT

7 IN ROUND

INCANDESCENT

4 IN X 6 IN

INCANDESCENT

6 IN X 10 IN

INCANDESCENT

4 IN ROUND

45[®] SERIES, LED, 15 DIODES, 3"X5", GROMMET MOUNT, KIT



- Direct replacement for approved lamps on the United States Postal Service L.L.V.
- Designed for mounting on a 7 - 11 degree rollback from the vertical plane
- Vertical-mount only



Part Number	Lamp Connector	Plug Side 1	Plug Side 2	Lens Color	Lens Material	Mount Color	Volts	Amps Major/Minor	Kit Includes
45032R	Hardwired	Hardwired	Packard Connector 12015793	Red	PC	Black	12	0.5/0.04	45701 grommet, 60701 grommet

LED
45 SERIES

60[®] SERIES, INCANDESCENT, 1 BULB, 2"X6", GROMMET MOUNT, KIT



- Direct replacement for approved lamps on the United States Postal Service L.L.V (Long Life Vehicles)
- Features a heavy-duty shock-mounted bulb
- Four versions, each features center high mount stop functions, park and turn functions, rear side marker and turn functions, or front side marker and turn signal functions

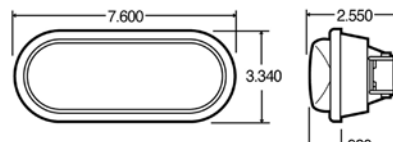

Part Number	Lamp Connector	Plug Side 1	Plug Side 2	Lens Color	Lens Material	Mount Color	Volts	Amps Major/Minor	Kit Includes/ Replacement Parts
60021R	PL-2	Right Angle PL-2	Packard Connector 12020398	Red	PC	Black	12	1.66/1.22	45701 grommet, 60701 grommet

INCANDESCENT
60 SERIES

60[®] SERIES, INCANDESCENT, 1 BULB, 2"X6", GROMMET MOUNT, KIT, REFLECTORIZED



- Direct replacement for approved lamps on the United States Postal Service L.L.V (Long Life Vehicles)
- Features a heavy-duty shock-mounted bulb
- Four versions, each features center high mount stop functions, park and turn functions, rear side marker and turn functions, or front side marker and turn signal functions

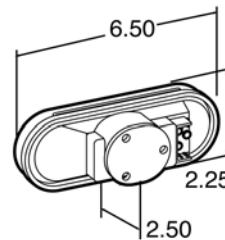

Part Number	Lamp Connector	Plug Side 1	Plug Side 2	Lens Color	Lens Material	Mount Color	Volts	Amps Major/Minor	Kit Includes/ Replacement Parts
60023R	PL-2	Right Angle PL-2	Packard Connector 12015793	Red	PC	Black	12	2.1/0.48	45701 grommet, 60701 grommet
60024Y	PL-3	Right Angle PL-3	Weather Connector 12015793	Yellow	PC	Black	12	2.1/0.48	60215Y signal, 60701 grommet, 94840 plug

INCANDESCENT
60 SERIES

LED

SINGLE FACE

SINGLE FACE, LED, 24 DIODE , 3 WIRES, ROUND, 1 STUD MOUNT

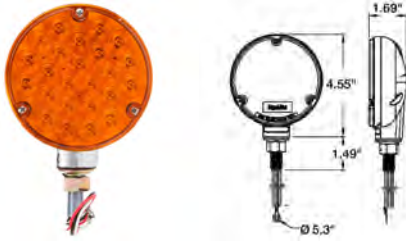

- Chrome plated housing
- Ideal for show trucks, highway, mowing, municipal and farm equipment



Part Number	Lamp Connector	Plug Side 1	Plug Side 2	Lens Color	Housing Material	Housing Color	Volts	Amps Major/Minor
2751	Hardwired	Hardwired	Stripped End Ring Terminal	Red	Zinc	Chrome	12	0.24/0.01
2751A	Hardwired	Hardwired	Stripped End Ring Terminal	Yellow	Zinc	Chrome	12	0.36/0.03
80867	Hardwired	Hardwired	Packard Connector	Yellow	Zinc	Black	12	0.36/0.03

LED

DUAL FACE

DUAL FACE, LED, 24 DIODE, 3 WIRES, ROUND, 1 STUD MOUNT

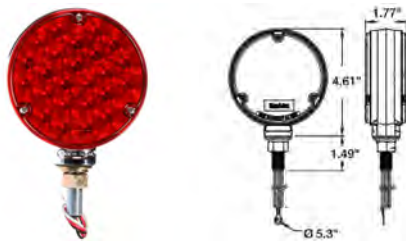

- Ideal for show trucks, highway, mowing, municipal and farm equipment
- Chrome-plated housing



Part Number	Lamp Connector	Plug Side 1	Plug Side 2	Lens Color	Housing Material	Housing Color	Volts	Amps Major/Minor
2750	Hardwired	Hardwired	Stripped End/Ring Terminal	Red Yellow	Zinc	Chrome	12	0.73/0.05

LED

DUAL FACE

DUAL FACE, LED, 24 DIODE, 2 WIRES, SQUARE, 1 STUD MOUNT



- Ideal for show trucks, highway, mowing, municipal and farm equipment
- Unique LED array displays full pattern output
- Side marker reflex reflector
- LEDs do not have a filament, therefore are not susceptible to damage from shock and vibration
- LEDs have less current draw, resulting in increased battery and alternator life while allowing more power for other vehicle requirements
- Chrome-plated housing
- Meets SAE J974 for agricultural warning devices
- Epoxy encapsulated electronics protect the lamp from damage caused by chemicals and moisture



Part Number	Lamp Connector	Plug Side 1	Plug Side 2	Lens Color	Housing Material	Housing Color	Volts	Amps Major/Minor
2752	Hardwired	Hardwired	Stripped End/Ring Terminal	Yellow	ABS	Chrome	12	0.45

DUAL FACE, LED, 24 DIODE, 3 WIRES, SQUARE, 1 STUD MOUNT



- Ideal for show trucks, highway, mowing, municipal and farm equipment
- Unique LED array displays full pattern output
- Side marker reflex reflector
- LEDs do not have a filament, therefore are not susceptible to damage from shock and vibration
- LEDs have less current draw, resulting in increased battery and alternator life while allowing more power for other vehicle requirements
- Chrome plated housing
- Meets SAE J974 for agricultural warning devices
- Epoxy-encapsulated electronics protect the lamp from damage caused by chemicals and moisture

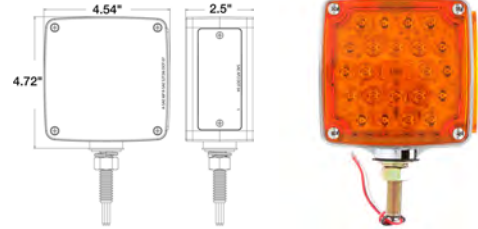

Part Number	Position	Lamp Connector	Plug Side 1	Plug Side 2	Lens Color	Housing Material	Housing Color	Volts	Amps Major/Minor
2753	LH	Hardwired	Hardwired	Stripped End/Ring Terminal	Red Yellow	Zinc	Chrome	12	0.38/0.04
2756	RH	Hardwired	Hardwired	Stripped End/Ring Terminal	Red Yellow	Zinc	Chrome	12	0.38/0.04

DUAL FACE, LED, 24 DIODE, 3 WIRES, SQUARE, 2 STUD MOUNT



- Ideal for show trucks, highway, mowing, municipal and farm equipment
- Unique LED array displays full pattern output
- Side marker reflex reflector
- LEDs do not have a filament, therefore are not susceptible to damage from shock and vibration
- LEDs have less current draw, resulting in increased battery and alternator life while allowing more power for other vehicle requirements
- Epoxy-encapsulated electronics protect the lamp from damage caused by chemicals and moisture
- Double-stud mount

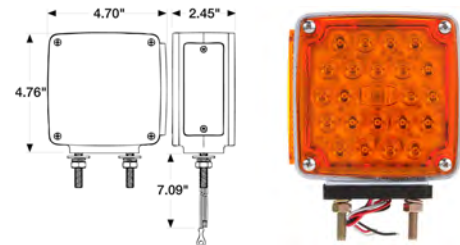

Part Number	Position	Lamp Connector	Plug Side 1	Plug Side 2	Lens Color	Housing Material	Housing Color	Volts	Amps Major/Minor
2758	RH	Hardwired	Hardwired	Stripped End/Ring Terminal	Red Yellow	Zinc	Chrome	12	0.38/0.04
2759	LH	Hardwired	Hardwired	Stripped End/Ring Terminal	Red Yellow	Zinc	Chrome	12	0.38/0.04

SINGLE FACE, INCANDESCENT, 1 WIRE, ROUND, 1 STUD MOUNT

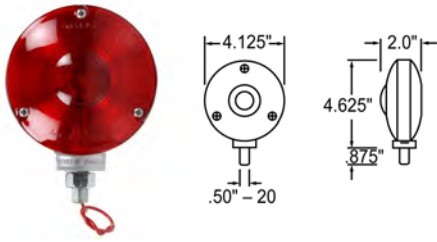

- For applications with vehicle width under 80" wide
- One-wire, signal lamp
- LED upgrade options available #2751, 2751A and 2750



Part Number	Lamp Connector	Plug Side 1	Plug Side 2	Lens Color	Housing Material	Housing Color	Volts	Amps Major/Minor
2701	Hardwired	Hardwired	Stripped End	Red	Zinc	Black	12	2.1
2701A	Hardwired	Hardwired	Stripped End	Yellow	Zinc	Black	12	2.1
3701	Hardwired	Hardwired	Stripped End	Red	Zinc	Gray	12	2.1
3711	Hardwired	Hardwired	Stripped End	Red	Zinc	Chrome	12	2.1
3711B	Hardwired	Hardwired	Stripped End	Blue	Zinc	Chrome	12	2.1

SINGLE FACE, INCANDESCENT, 2 WIRE, ROUND, 1 STUD MOUNT, SHOCK MOUNT



- For vehicle application with vehicle width under 80" wide
- Two-wire, stop, tail, turn lamp
- Zinc die-cast housing



Part Number	Lamp Connector	Plug Side 1	Plug Side 2	Lens Color	Housing Material	Housing Color	Volts	Amps Major/Minor
3710	Hardwired	Hardwired	Stripped End	Red	Zinc	Gray	12	2.1/0.59

Keep Your Connections Safe. Don't Forget Your Dielectric Gel.

Dielectric gel protects your lights by protecting the points of contact between elements of your lighting and harness system. Our dielectric compounds prevent arcing and corrosion and keep your lights performing as they should.

You can find our dielectric products on page 498



SINGLE FACE, INCANDESCENT, 2 WIRE, ROUND, 1 STUD MOUNT



- Two-wire, stop, tail, turn lamp
- Rubber O-ring seals out dirt and moisture
- Snap-on lens for easy bulb replacement
- LED upgrade options available #2751/2751A

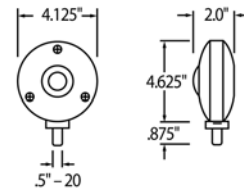

Part Number	Lamp Connector	Plug Side 1	Plug Side 2	Lens Color	Housing Material	Housing Color	Volts	Amps Major/Minor
2702	Hardwired	Hardwired	Stripped End	Red	Zinc	Black	12	2.1/0.59
2702A	Hardwired	Hardwired	Stripped End	Yellow	Zinc	Black	12	2.1/0.59
3702	Hardwired	Hardwired	Stripped End	Red	Zinc	Gray	12	2.1/0.59
3712	Hardwired	Hardwired	Stripped End	Red	Zinc	Chrome	12	2.1/0.59
3762	Hardwired	Hardwired	Stripped End	Red	Zinc	Silver	12	2.1/0.59

INCANDESCENT

SINGLE FACE

SINGLE FACE, INCANDESCENT, 1 WIRE, ROUND, 1 STUD MOUNT



- Available as single or dual-face lamps
- Dual-face lamp mounts on a 3/8"-24 stud
- Single-face lamp mounts on a 7/16" -14 stud
- Features snap-in lens
- LED upgrade options available #2751, 2751A and 2750

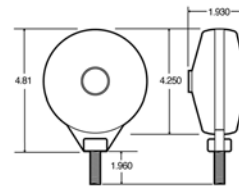

Part Number	Lamp Connector	Plug Side 1	Plug Side 2	Lens Color	Housing Material	Housing Color	Volts	Amps Major/Minor
3755A	Hardwired	Hardwired	Stripped End	Yellow	PC	Black	12	2.1
70330R	Hardwired	Hardwired	Blunt Cut	Red	PC	Gray	12	2.1
70330Y	Hardwired	Hardwired	Blunt Cut	Yellow	PC	Gray	12	2.1
3755	Hardwired	Hardwired	Stripped End	Red	PC	Black	12	2.1

INCANDESCENT

SINGLE FACE

SINGLE FACE, INCANDESCENT, 1 WIRE, ROUND, 1 STUD MOUNT, SNAP ON LENS



- Available as single or dual-face lamps
- Dual-face lamp mounts on a 3/8"-24 stud
- Single-face lamp mounts on a 7/16" -14 stud
- Features snap-in lens
- LED upgrade options available #2751, 2751A and 2750

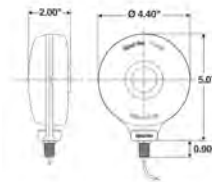

Part Number	Lamp Connector	Plug Side 1	Plug Side 2	Lens Color	Housing Material	Housing Color	Volts	Amps Major/Minor
3753	Hardwired	Hardwired	Stripped End	Red	PC	White	12	2.1
3753A	Hardwired	Hardwired	Stripped End	Yellow	PC	White	12	2.1

INCANDESCENT

SINGLE FACE

SINGLE FACE, INCANDESCENT, 2 WIRE, ROUND, 1 STUD MOUNT



- Snap-on lens simplifies bulb and lens replacement
- Tough polycarbonate housing prevents rust and corrosion
- LED upgrade Options Available: 2751, 2751A and 2750



Part Number	Lamp Connector	Plug Side 1	Plug Side 2	Lens Color	Housing Material	Housing Color	Volts	Amps Major/Minor
70310R	Hardwired	Hardwired	Blunt Cut	Red	PC	Gray	12	2.1/0.59
3756	Hardwired	Hardwired	Stripped End	Red	PC	Black	12	2.1/0.59
3754	Hardwired	Hardwired	Stripped End Ring Terminal	Red	PC	White	12	2.1/0.59

DUAL FACE, INCANDESCENT, 1 WIRE, ROUND, 1 STUD MOUNT

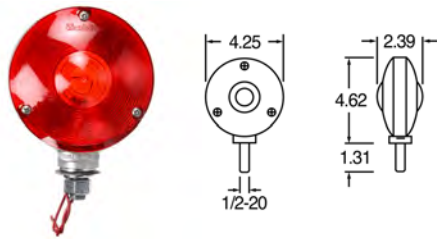

- 3805Y115 requires Phillips #28S 11/4SC or GE #13655 bulb
- For vehicle application with vehicle width under 80" wide
- Pigtail with spring and thermoplastic wire exits via hollow stud
- LED upgrade options available: 2751, 2751A and 2750



Part Number	Lamp Connector	Plug Side 1	Plug Side 2	Lens Color	Housing Material	Housing Color	Volts	Amps Major/Minor	Lens Type
2801	Hardwired	Hardwired	Stripped End	Red Yellow	Zinc	Black	12	2.1	
3801	Hardwired	Hardwired	Stripped End	Red Yellow	Zinc	Gray	12	2.1	3-Screw
3802	Hardwired	Hardwired	Stripped End	Red Yellow	Zinc	Chrome	12	2.1	
3860	Hardwired	Hardwired	Stripped End	Red Yellow	Zinc	Gray	12	2.1	0-Ring

DUAL FACE, INCANDESCENT, 1 WIRE, ROUND, 1 STUD MOUNT, SHOCK MOUNT

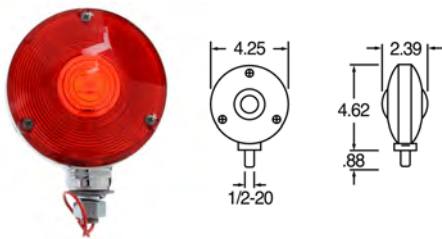

- 3805Y115 requires Phillips #28S 11/4SC or GE #13655 bulb
- For vehicle application with vehicle width under 80" wide
- Pigtail with spring and thermoplastic wire exits via hollow stud
- LED upgrade options available: 2751, 2751A and 2750



Part Number	Lamp Connector	Plug Side 1	Plug Side 2	Lens Color	Housing Material	Housing Color	Volts	Amps Major/Minor
3806	Hardwired	Hardwired	Stripped End	Red Yellow	Zinc	Chrome	12	2.1

INCANDESCENT

SINGLE FACE

INCANDESCENT

DUAL FACE

INCANDESCENT

DUAL FACE

DUAL FACE, INCANDESCENT, 1 WIRE, ROUND, 1 STUD MOUNT, 0-RING LENS GASKET



- Snap-Grip lens allows quick bulb and lens replacement
- O-ring lens gasket seals out dirt and moisture
- Mounting: Hollow stud, 1/2" diameter
- Can use 9199 or 9296 mounting brackets

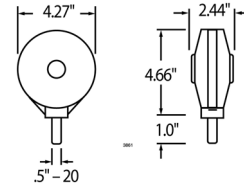

Part Number	Lamp Connector	Plug Side 1	Plug Side 2	Lens Color	Housing Material	Housing Color	Volts	Amps Major/Minor
3861	Hardwired	Hardwired	Stripped End	Red Yellow	Zinc	Chrome	12	2.1

INCANDESCENT

DUAL FACE

DUAL FACE, INCANDESCENT, 2 WIRE, ROUND, 1 STUD MOUNT



- Snap-Grip lens allows quick bulb and lens replacement
- O-ring lens gasket seals out dirt and moisture
- Mounting: Hollow stud, 1/2" diameter
- Can use 9199 or 9296 mounting brackets

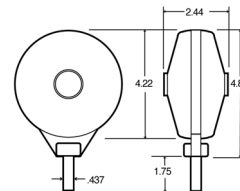

Part Number	Lamp Connector	Plug Side 1	Plug Side 2	Lens Color	Housing Material	Housing Color	Volts	Amps Major/Minor
70311	Hardwired	Hardwired	Blunt Cut	Red Yellow	PC	Yellow	12	2.1/0.59

INCANDESCENT

DUAL FACE

DUAL FACE, INCANDESCENT, 2 WIRE, ROUND, 1 STUD MOUNT, KNOCK DOWN



- Ideal for highway mowing, municipal lawn, and farm equipment
- Spring-loaded "Knock-Down" feature allows lamp to flex under impact and return to original position
- Meets SAE J974 for agricultural warning devices

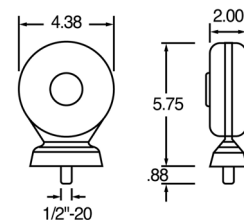

Part Number	Lamp Connector	Plug Side 1	Plug Side 2	Lens Color	Housing Material	Housing Color	Volts	Amps Major/Minor
3853AA	Hardwired	Hardwired	Stripped End	Yellow	PC	Yellow	12	2.1/0.59

INCANDESCENT

DUAL FACE

DUAL FACE, INCANDESCENT, 2 WIRE, ROUND, 1 STUD MOUNT

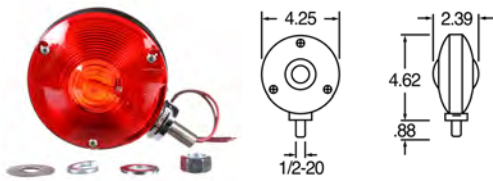

- 3805Y115 requires Phillips #28S 11/4SC or GE #13655 bulb
- For vehicle application with vehicle width under 80" wide
- Pigtail with spring and thermoplastic wire exits via hollow stud
- LED upgrade options available: 2751, 2751A and 2750



Part Number	Lamp Connector	Plug Side 1	Plug Side 2	Lens Color	Housing Material	Housing Color	Volts	Amps Major/Minor
2803	Hardwired	Hardwired	Stripped End	Red Yellow	Zinc	Black	12	2.1/0.59
3805Y115	Hardwired	Hardwired	Stripped End	Red	Zinc	Gray	12	2.1/0.59
3812	Hardwired	Hardwired	Stripped End	Red Yellow	Zinc	Chrome	12	2.1/0.59
3862	Hardwired	Hardwired	Stripped End	Red Yellow	Zinc	Gray	12	2.1/0.59
3863	Hardwired	Hardwired	Stripped End	Red Yellow	Zinc	Gray	12	2.1/0.59

DUAL FACE, INCANDESCENT, ZINC, 3 WIRE, ROUND, 1 STUD MOUNT,

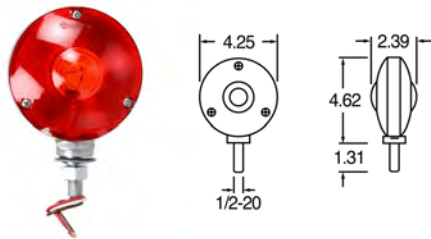

- 3805Y115 requires Phillips #28S 11/4SC or GE #13655 bulb
- For vehicle application with vehicle width under 80" wide
- Pigtail with spring and thermoplastic wire exits via hollow stud
- LED upgrade options available: 2751, 2751A and 2750



Part Number	Lamp Connector	Plug Side 1	Plug Side 2	Lens Color	Number of Bulbs	Housing Color	Volts	Amps Major/Minor
3810	Hardwired	Hardwired	Stripped End	Red Yellow	1	Chrome	12	2.1

DUAL FACE, INCANDESCENT, POLYCARBONATE, 3 WIRE, ROUND, 1 STUD MOUNT, KNOCK DOWN

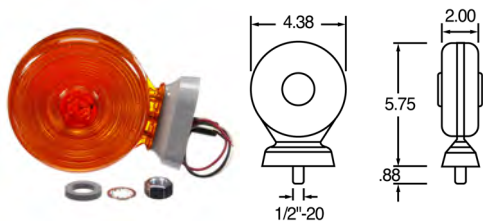

- Ideal for highway mowing, municipal lawn, and farm equipment
- Spring-loaded "Knock-Down" feature allows lamp to flex under impact and return to original position
- Meets SAE J974 for agricultural warning devices



Part Number	Lamp Connector	Plug Side 1	Plug Side 2	Lens Color	Number of Bulbs	Housing Color	Volts	Amps Major/Minor
3854	Hardwired	Hardwired	Stripped End	Red Yellow	1	Yellow	12	2.1/0.59

INCANDESCENT

DUAL FACE

INCANDESCENT

DUAL FACE

INCANDESCENT

DUAL FACE

DUAL FACE, INCANDESCENT, POLYCARBONATE, 1 WIRE, ROUND , 1 STUD MOUNT



- High-impact black polycarbonate housing will not rust or corrode
- Lamp grounds through mounting stud
- Snap-grip lens simplifies bulb and lens replacement
- LED upgrade options available: 2751, 2751A and 2750

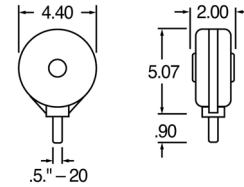

Part Number	Lamp Connector	Plug Side 1	Plug Side 2	Lens Color	Number of Bulbs	Housing Color	Volts	Amps Major/Minor
3850	Hardwired	Hardwired	Stripped End	Red Yellow	1	Black	12	2.1
3850AA	Hardwired	Hardwired	Stripped End	Yellow	1	Black	12	2.1
70300	Hardwired	Hardwired	Stripped End	Red Yellow	1	White	12	2.1

INCANDESCENT

DUAL FACE

Looking for even more product information?

Visit truck-lite.com



Powerful Search Function



360° Product Images



Easy-To-Find Replacement Parts

SINGLE FACE, INCANDESCENT, SQUARE, BRACKET MOUNT, KIT

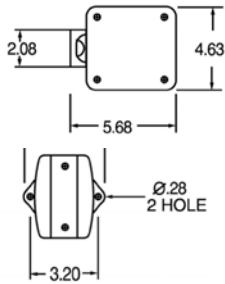

- Replaces GM #694627 (LH) and #694628 (RH)
- Combination park, turn, side marker and reflex reflector
- Mounting hardware included
- Mounts on 3.20" centers and connects with 2 spade terminals
- Unique GM harness connector (harness not available from Truck-Lite)



Part Number	Position	Lamp Connector	Lens Color	Housing Material	Housing Color	Volts	Amps Major/Minor	Kit Includes/ Replacement Parts
4854	RH	Spade Terminal	Red Yellow	ABS	Black	12	2.1/0.5	9063 lens, 9078A lens, 9080A lens
4855	LH	Spade Terminal	Red Yellow	ABS	Black	12	2.1/0.5	9063 lens, 9078A lens, 9080A lens

DUAL FACE, INCANDESCENT, ZINC, 1 WIRE, SQUARE, SURFACE MOUNT

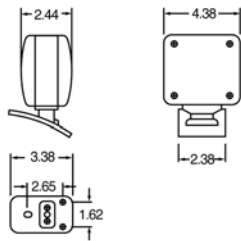

- Blade-type connector
- Die-cast base assembly
- Dual-optic lenses
- Mounting bracket included



Part Number	Lamp Connector	Plug Side 1	Plug Side 2	Lens Color	Number of Bulbs	Housing Color	Volts	Amps Major/Minor
950	Hardwired	Hardwired	Packard Connector	Red Yellow	1	Chrome	12	2.1

DUAL FACE, INCANDESCENT, POLYCARBONATE, SQUARE, BRACKET MOUNT, KIT

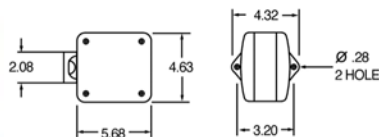

- GM #2029217
- Combination park, turn, side marker, and reflex reflector
- Mounts on 3.25" centers and connects with 3 spade terminals
- Fits left or right side
- Unique GM harness connector (harness not available from Truck-Lite)



Part Number	Lamp Connector	Lens Color	Number of Bulbs	Mount Color	Volts	Amps Major/Minor	Kit Includes
4872AA	Spade Terminal	Yellow	1	Black	12	2.1/0.5	9083A lens

INCANDESCENT

SINGLE FACE

INCANDESCENT

DUAL FACE

INCANDESCENT

DUAL FACE

DUAL FACE, INCANDESCENT, ZINC, 2 WIRE, SQUARE, BRACKET MOUNT, KIT



- Die-cast base assembly
- Receptacle type connector
- Mounting bracket included

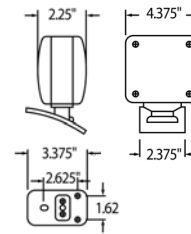

Part Number	Lamp Connector	Plug Side 1	Plug Side 2	Lens Color	Number of Bulbs	Mount Color	Volts	Amps Major/Minor	Kit Includes
956AA	Hardwired	Hardwired	Female .180 Bullet	Yellow	1	Chrome	12	2.1/0.5	8960 lens, 8960A lens
957AA	Hardwired	Hardwired	.180 Bullet/ Female .180 Bullet	Yellow	1	Chrome	12	2.1/0.5	8960 lens, 8960A lens

INCANDESCENT

DUAL FACE

DUAL FACE, INCANDESCENT, 1 WIRE, SQUARE, 1 STUD MOUNT



- Dual-optic lenses
- Die-cast base assembly
- Mounts left or right, horizontally or vertically
- Mounting hardware for stud or pedestal installation

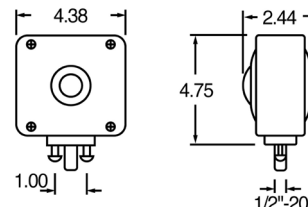

Part Number	Lamp Connector	Plug Side 1	Plug Side 2	Lens Color	Housing Material	Housing Color	Volts	Amps Major/Minor
955	Hardwired	Hardwired	Stripped End	Red Yellow	Zinc	Black	12	2.1/0.5

INCANDESCENT

DUAL FACE

DUAL FACE, INCANDESCENT, POLYCARBONATE, 3 WIRE, RECTANGULAR, 2 STUD MOUNT



- Combination lamp functions as turn signal, side marker and parking lamp with reflector
- High-impact plastic housing resists rust and corrosion
- Wire harness enclosed in weather proof housing

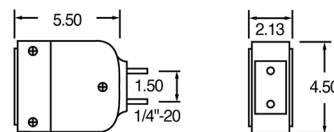

Part Number	Lamp Connector	Plug Side 1	Plug Side 2	Lens Color	Number of Diodes	Housing Color	Volts	Amps Major/Minor
4701	Hardwired	Hardwired	Stripped End	Red Yellow	2	Black	12	2.1/0.5
4702	Hardwired	Hardwired	Stripped End	Red Yellow	2	Black	12	2.1/0.5

INCANDESCENT

DUAL FACE

INCANDESCENT
DUAL FACE

DUAL FACE, INCANDESCENT, POLYCARBONATE, 2 WIRE, SQUARE, 1 STUD MOUNT

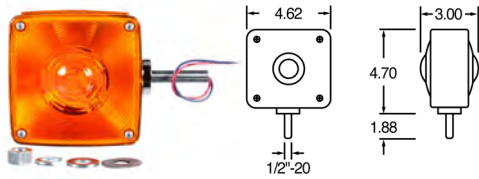

- Black-housed version is a popular Western Star replacement
- Chrome-housed version is a popular replacement for Volvo and Peterbilt
- Combination park, turn, side marker and reflex reflector
- Standard on many OEM applications
- High-impact non-corrosive polycarbonate housing
- Side marker and reflector included in design

Part Number	Lamp Connector	Plug Side 1	Plug Side 2	Lens Color	Number of Bulbs	Housing Color	Volts	Amps Major/Minor
4800	Hardwired	Hardwired	Stripped End	Red Yellow	2	Black	12	2.1/0.5
4801	Hardwired	Hardwired	Stripped End	Red Yellow	2	Chrome	12	2.1/0.5
4810	Hardwired	Hardwired	Stripped End	Red Yellow	2	Black	12	2.1/0.5

INCANDESCENT
DUAL FACE

DUAL FACE, INCANDESCENT, POLYCARBONATE, 2 WIRE, SQUARE, 2 STUD MOUNT

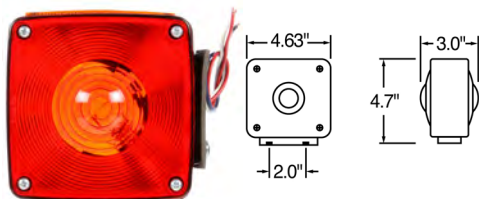

- Ground wire added for use on fiberglass fenders
- High-impact non-corrosive polycarbonate housing
- Mounting pad and two 1/4"-20 bolts included
- Side marker and reflector included in design

Part Number	Lamp Connector	Plug Side 1	Plug Side 2	Lens Color	Number of Bulbs	Housing Color	Volts	Amps Major/Minor
4805	Hardwired	Hardwired	Stripped End	Red Yellow	2	Black	12	2.1/0.5

DUAL FACE, INCANDESCENT, POLYCARBONATE, 3 WIRE, RECTANGULAR, 2 STUD MOUNT



- 4805AAY115 includes OEM 7" harness that mates with truck harness - simplifying replacement
- 4805AAY118 included 75" OEM mating harness
- Dual-optic lens
- Polycarbonate lens and housing
- Side marker and reflector included in design
- Mounting pad included
- Two 5/16" studs on 2" centers

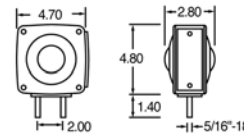

Part Number	Lamp Connector	Plug Side 1	Plug Side 2	Lens Color	Number of Bulbs	Housing Color	Volts	Amps Major/Minor
4805AAY115	Hardwired	Hardwired	Packard 12010996/ Packard 12010973	Yellow	2	Black	12	2.1/0.5
4805AAY118	Hardwired	Hardwired	Packard 12015791/ Packard 12015792	Yellow	2	Black	12	2.1/0.5
4805AY116	Hardwired	Hardwired	Packard 12052457	Red Yellow	2	Chrome	12	2.1/0.5
4805AY117	Hardwired	Hardwired	Packard 12052457	Red Yellow	2	Chrome	12	2.1/0.5
4874AY101	Hardwired	Hardwired	.180 Bullet/ Female .180 Bullet	Yellow	1	Chrome	12	2.1/0.5

5800 SERIES, DUAL FACE, INCANDESCENT, POLYCARBONATE, 3 WIRE, RECTANGULAR, 2 STUD MOUNT



- Polycarbonate snap-On/snap-off lens - no screws
- Special Packard Metri-Pack connector
- Combination side marker lamp and reflex reflector lens
- Mounts left or right
- Unbreakable, easy bulb replacement one lens sealed, one lens snaps on/off
- For quick, easy connection that eliminates corrosion
- Isolates the bulb from the jarring effects of road shock and vibration
- For front turn signal, park and side marker
- Eliminates the need for separate side marker lamp and reflex reflector
- Positive lens fit, corrosion proof, watertight
- GM #15565531

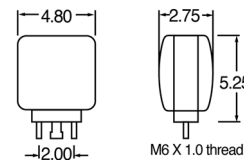

Part Number	Lamp Connector	Plug Side 1	Plug Side 2	Lens Color	Number of Bulbs	Housing Color	Volts	Amps Major/Minor
5800AA	Packard Connector	Packard Connector	Stripped End	Yellow	1	Black	12	2.1/0.59
5800AAK	Packard Connector	Packard Connector	Stripped End	Yellow	1	Black	12	2.1/0.59

LIGHT MODULES

LED MODULES

Pages 108-110

SERIES	PAGES
40® Series	108-109
Super 44®	109
Signal-Stat	110

LED / INCANDESCENT MODULES

Pages 110-112

SERIES	PAGES
40® Series	110
45® Series	111-112

INCANDESCENT MODULES

Pages 113-117

SERIES	PAGES
40® Series	113-116
Signal-Stat	117

40[®] SERIES, LED, STOP/TURN/TAIL

LED

40 SERIES

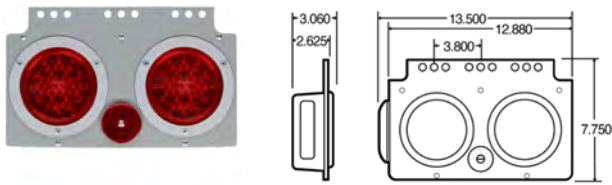

- Features universal mount designed to retrofit a wide variety of vehicles
- Kits include metal mounting box with side marker lamp and reflector
- Optional mounting gasket available to provide extra seal between module and body
- Truck-Lite or Signal-Stat LED lighting modules also available



Part Number	Position	Mount/Trim Color	S/T/T Light Part#	Harness Part#	Harness Part#	Volts
40626	LH	Gray	40626	44222R	50200	12
40627	RH	Gray	40626	44222R	50200	12

MODULE COMPONENTS

	S/T/T Light Part#	Harness Part#	Harness Part#
Part #	40626	44222R	50200
Quantity	2	1	1

Standards Met	Compliance Family
A I6 P2 S2 T	FMVSS 108 CMVSS 108 DOT SAE

40[®] SERIES, LED, STOP/TURN/TAIL | MARKER CLEARANCE

LED

40 SERIES

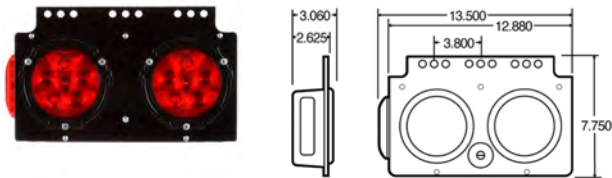

- Features universal mount designed to retrofit a wide variety of vehicles
- Kits include metal mounting box with side marker lamp and reflector
- Optional mounting gasket available to provide extra seal between module and body
- Truck-Lite or Signal-Stat LED lighting modules also available



Part Number	Position	Mount/Trim Color	S/T/T Light Part#	M/C Light Part#	Volts
40637	LH	Black	44326R	19250R	12
40638	RH	Black	44326R	19250R	12

MODULE COMPONENTS

	S/T/T Light Part#	M/C Light Part#
Part #	44326R	19250R
Quantity	2	1

Standards Met	Compliance Family
A I6 P2 S2 T	FMVSS 108 CMVSS 108 DOT SAE

40[®] SERIES, LED, BACK-UP | LICENSE | STOP/TURN/TAIL



- Mounts between frame rail
- Features heavy-gauge metal module
- Comes with pre-assembled junction box with wiring harness
- 40894 features Peterbilt replacement with red LED lamps and excludes junction box

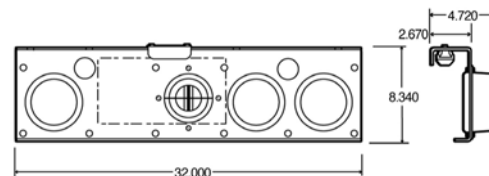

Part Number	Mount/Trim Color	B/U Light Part#	License Light Part#	S/T/T Light Part#	Grommet Part#	Volts
40894	Black	40204	19206	44302R	40700	12

MODULE COMPONENTS

Part #	B/U Light Part#	License Light Part#	S/T/T Light Part#	Grommet Part#
Part #	40204	19206	44302R	40700
Quantity	1	1	2	3

Standards Met	Compliance Family
S2 I6 A R T	FMVSS 108 CMVSS 108 DOT SAE

SUPER 44[®], LED, STOP/TURN/TAIL | BACK-UP | TURN SIGNAL | SIDE MARKER



- Popular on straight truck applications
- Features metal module box with side marker and back-up lamps

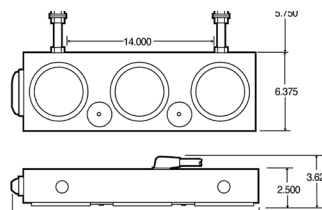

Part Number	Position	Mount/Trim Color	S/T/T Light Part#	Turn Signal Light Part#	B/U Light Part#	M/C Light Part#	Grommet Part#	Volts
44808	RH	Black	44302R	44201Y	44206C	19250R	40700	12
44809	LH	Black	44302R	44201Y	44206C	19250R	40700	12

MODULE COMPONENTS

Part #	S/T/T Light Part#	Turn Signal Light Part#	B/U Light Part#	M/C Light Part#	Grommet Part#
Part #	44302R	44201Y	44206C	19250R	40700
Quantity	1	1	1	1	3

Standards Met	Compliance Family
A I6 P2 R S2 T	FMVSS 108 CMVSS 108 DOT SAE

LED

SIGNAL-STAT

SIGNAL-STAT, LED, MARKER CLEARANCE | STOP/TURN/TAIL, KIT

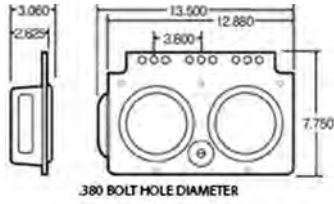

- Features universal mount designed to retrofit a wide variety of vehicles
- Kits include metal mounting box with side marker lamp and reflector
- Optional mounting gasket available to provide extra seal between module and body
- Truck-Lite or Signal-Stat LED lighting modules also available



Part Number	Position	Mount/Trim Color	M/C Light Part#	S/T/T Light Part#	Grommet Part#	Volts
9536	LH	Black	1960	4050	40700	12
9537	RH	Black	1960	4050	40700	12

MODULE COMPONENTS

Part #	M/C Light Part#	S/T/T Light Part#	Grommet Part#
Part #	1960	4050	40700
Quantity	1	2	2

Standards Met	Compliance Family
A I6 P2 S2 T	FMVSS 108 CMVSS 108 DOT SAE

LED / INCANDESCENT

40 SERIES

40® SERIES, LED, STOP/TURN/TAIL | BACK-UP | TURN SIGNAL | SIDE MARKER

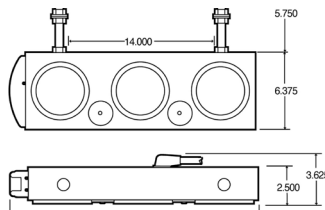

- Popular on straight truck applications
- Features metal module box with side marker and back-up lamps



Part Number	Position	Mount/Trim Color	S/T/T Light Part#	Turn Signal Light Part#	B/U Light Part#	M/C Light Part#	Grommet Part#	Volts
40808	RH	Black	44302R	44201Y	40244	21201R	40700	12
40809	LH	Black	44302R	44201Y	40244	21201R	40700	12

MODULE COMPONENTS

Part #	S/T/T Light Part#	Turn Signal Light Part#	B/U Light Part#	M/C Light Part#	Grommet Part#
Part #	44302R	44201Y	40244	21201R	40700
Quantity	1	1	1	1	3

Standards Met	Compliance Family
A I6 P2 R S2 T	FMVSS 108 CMVSS 108 DOT SAE

45[®] SERIES, LED/INCANDESCENT, STOP/TURN/TAIL | BACK-UP | TURN SIGNAL



- Features weather-resistant synthetic rubber and polypropylene construction
- Three-lamp module includes one each multi-volt LED S/T lamp, LED turn signal lamp and sealed reverse lamp
- Mounts on four studs, each set on 78mm centers, 131mm apart
- Module includes a 1.25m harness

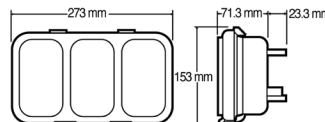

Part Number	Position	Mount/Trim Color	Lamp Connection	Plug Side 1	Plug Side 2	Volts
45420	RH	Black	Hardwired PL-2	PL-2	Blunt Cut	24
45423	LH	Black	Hardwired PL-2	PL-2	Blunt Cut	24
45430	RH	Black	Hardwired PL-2	PL-2	Blunt Cut	12
45433	LH	Black	Hardwired PL-2	PL-2	Blunt Cut	12

Standards Met	Compliance Family
R3 R6 R7 R23	ECE

45[®] SERIES, LED/INCANDESCENT, STOP/TURN/TAIL | TURN SIGNAL | REAR FOG LAMP



- Features weather-resistant synthetic rubber and polypropylene construction
- Three-lamp module includes one each multi-volt LED rear position/stop lamp, direction indicator lamp and rear fog lamp
- Mounts on four studs, each set on 78mm centers, 131mm apart
- Module includes a 1.25m harness

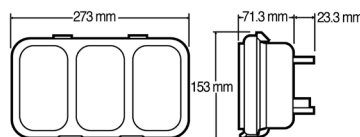

Part Number	Position	Mount/Trim Color	Lamp Connection	Plug Side 1	Plug Side 2	Volts
45421	RH	Black	Hardwired	Hardwired	Blunt Cut	12 24
45422	LH	Black	Hardwired	Hardwired	Blunt Cut	12 24

Standards Met	Compliance Family
R6 R7 R38	ECE

45® SERIES, LED/INCANDESCENT, STOP/TURN/TAIL | BACK-UP | TURN SIGNAL | REAR FOG LAMP

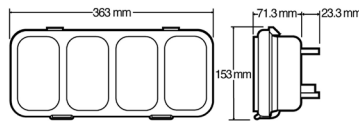

- Features weather-resistant synthetic rubber and polypropylene construction
- Four-lamp module includes one each multi-volt LED rear position/stop lamp, LED direction indicator lamp, LED rear fog lamp and sealed reverse lamp
- Mounts on four studs, each set on 78mm centers, 219mm apart
- Module includes a 1.25m harness



Part Number	Position	Mount/Trim Color	Lamp Connection	Plug Side 1	Plug Side 2	Volts
45626	RH	Black	Hardwired PL-2	PL-2	Blunt Cut	24
45627	LH	Black	Hardwired PL-2	PL-2	Blunt Cut	24

Standards Met	Compliance Family
R3 R6 R7 R23 R38	ECE

Part Number	Position	Mount/Trim Color	Lamp Connection	Plug Side 1	Plug Side 2	Volts
45630	RH	Black	Hardwired PL-2	PL-2	Blunt Cut	12
45631	LH	Black	Hardwired PL-2	PL-2	Blunt Cut	12

Standards Met	Compliance Family
R6 R7 R23	ECE

40® SERIES, INCANDESCENT, STOP/TURN/TAIL, PVC

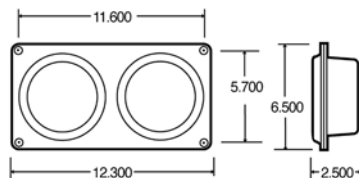

- Features high-impact plastic module box
- Mounts in 11" x 5.12" hole
- Optional mounting gasket available to provide extra seal between module and body



Part Number	Position	Mount/Trim Color	S/T/T Light Part#	Harness	Harness	Grommet	Housing	Volts
40742	LH	Black	40202R	50200	50201	40700	40722	12
40743	RH	Black	40202R	50200	50201	40700	40722	12

MODULE COMPONENTS

	S/T/T Light Part#	Harness	Harness	Grommet	Housing
Part #	40202R	50200	50201	40700	40722
Quantity	2	1	1	2	1

Standards Met	Compliance Family
P2 S2 I6 T	FMVSS 108 CMVSS 108 DOT SAE

40[®] SERIES, INCANDESCENT, STOP/TURN/TAIL, STEEL



- Features metal mounting flange with high-impact plastic module box
- Optional mounting gasket #97938 available to provide extra seal between module and body

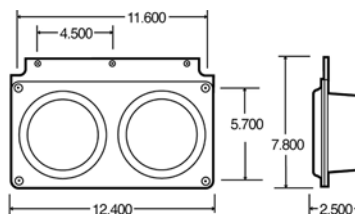

Part Number	Position	Mount/Trim Color	S/T/T Light Part#	Harness	Harness	Grommet	Housing	Flange Mount	Volts
40746	LH	Black	40202R	50200	50201	40700	40722	40721	12
40747	RH	Black	40202R	50200	50201	40700	40722	40721	12

MODULE COMPONENTS

	S/T/T Light Part#	Harness	Harness	Grommet	Housing	Flange Mount
Part #	40202R	50200	50201	40700	40722	40721
Quantity	2	1	1	2	3	1

Standards Met	Compliance Family
S2 I6 R T	FMVSS 108 CMVSS 108 DOT SAE

40[®] SERIES, INCANDESCENT, STOP/TURN/TAIL | TURN SIGNAL | SIDE MARKER, STEEL



- Popular on straight truck applications
- Features metal module box with side marker and turn signal lamps

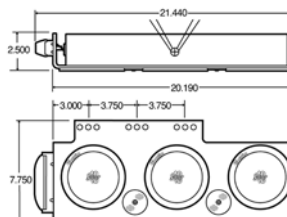

Part Number	Position	Mount/Trim Color	S/T/T Light Part#	Turn Signal Light Part#	M/C Light Part#	Grommet Part#	Volts
40762	LH	Black	40242R	40241Y	19200R	40700	12
40763	RH	Black	40242R	40241Y	19200R	40700	12

MODULE COMPONENTS

	S/T/T Light Part#	Turn Signal Light Part#	M/C Light Part#	Grommet Part#
Part #	40242R	40241Y	19200R	40700
Quantity	2	1	1	3

Standards Met	Compliance Family
I6 A P2 T	FMVSS 108 CMVSS 108 DOT SAE

40® SERIES, INCANDESCENT, STOP/TURN/TAIL | MARKER CLEARANCE | SIDE MARKER

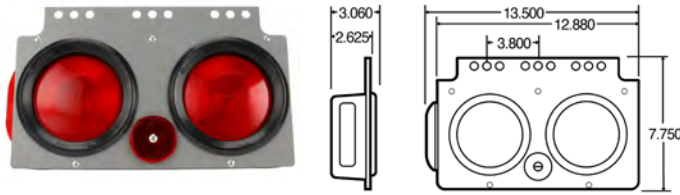

- Features universal mount designed to retrofit a wide variety of vehicles
- Kits include metal mounting box with side marker lamp and reflector
- Optional mounting gasket available to provide extra seal between module and body
- Truck-Lite or Signal-Stat LED lighting modules also available



Part Number	Position	Mount/Trim Color	S/T/T Light Part#	M/C Light Part#	Grommet	Volts
40756	LH	Black	40202R	19200R	40700	12
40757	RH	Black	40202R	19200R	40700	12

MODULE COMPONENTS

Part #	S/T/T Light Part#	M/C Light Part#	Grommet
Part #	40202R	19200R	40700
Quantity	2	1	2

Standards Met	Compliance Family
A I6 P2 S2 T	FMVSS 108 CMVSS 108 DOT SAE

40® SERIES, INCANDESCENT, STOP/TURN/TAIL | BACK-UP | TURN SIGNAL | SIDE MARKER

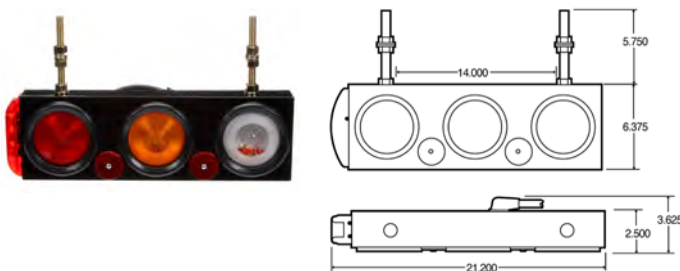

- Popular on straight truck applications
- Features metal module box with side marker and back-up lamps
- Upgrade to LED lighting system, use part #40808 and 40809



Part Number	Position	Mount/Trim Color	S/T/T Light Part#	Turn Signal Light Part#	B/U Light Part#	M/C Light Part#	Grommet	Volts
40790	RH	Black	40242R	40241Y	40244	21201R	40700	12
40791	LH	Black	40242R	40241Y	40244	21201R	40700	12

MODULE COMPONENTS

Part #	S/T/T Light Part#	Turn Signal Light Part#	B/U Light Part#	M/C Light Part#	Grommet
Part #	40242R	40241Y	40244	21201R	40700
Quantity	1	1	1	1	3

Standards Met	Compliance Family
A I6 P2 R S2 T	FMVSS 108 CMVSS 108 DOT SAE

40[®] SERIES, INCANDESCENT, STOP/TURN/TAIL | BACK-UP | SIDE MARKER



- Popular on straight truck applications
- Features metal module box with side marker and back-up lamps

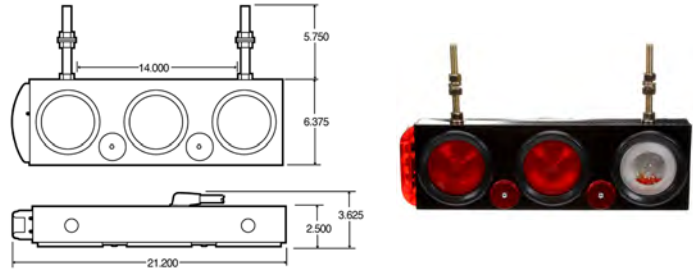

Part Number	Position	Mount/Trim Color	Lamp Connection	Plug Side 1	Plug Side 2	Volts
40758	LH	Black	PL-2	PL-2	Ring Terminal	12
40759	RH	Black	PL-2	PL-2	Ring Terminal	12

REPLACEMENT PARTS / KIT COMPONENTS

Module Part#	S/T/T Light Part#	B/U Light Part#	M/C Light Part#	Grommet
40758	40242R	40244	21201R	40700
40759	40242R	40244	21201R	40700

Standards Met	Compliance Family
A I6 P2 R S2 T	FMVSS 108 CMVSS 108 DOT SAE

40[®] SERIES, INCANDESCENT, STOP/TURN/TAIL | BACK-UP | LICENSE



- Mounts between frame rail
- Features heavy-gauge metal module
- Comes with pre-assembled junction box with wiring harness

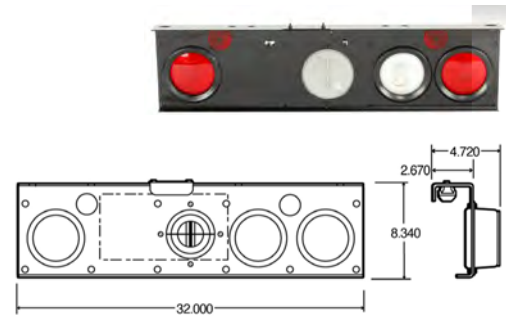

Part Number	Mount/Trim Color	S/T/T Light Part#	B/U Light Part#	License Light Part#	Grommet	Volts
40850	Black	40242R	40204	19206	40700	12

MODULE COMPONENTS

	S/T/T Light Part#	B/U Light Part#	License Light Part#	Grommet
Part #	40242R	40204	19206	40700
Quantity	2	1	1	3

Standards Met	Compliance Family
A I6 P2 R S2 T	FMVSS 108 CMVSS 108 DOT SAE

40® SERIES, INCANDESCENT, STOP/TURN/TAIL | BACK-UP, KIT

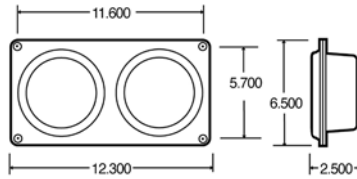

- Features high-impact plastic module box
- Mounts in 11" x 5.12" hole
- Optional mounting gasket available to provide extra seal between module and body



Part Number	Position	Mount/Trim Color	S/T/T Light Part#	B/U Light Part#	Harness	Housing	Grommet	Volts
40748	LH	Black	40242R	40244	50201	40722	40700	12
40749	RH	Black	40242R	40244	50201	40722	40700	12

MODULE COMPONENTS

Part #	S/T/T Light Part#	B/U Light Part#	Harness	Housing	Grommet
Part #	40242R	40244	50201	40722	40700
Quantity	1	1	1	1	2

Standards Met	Compliance Family
P2 S2 I6 T	FMVSS 108 CMVSS 108 DOT SAE

40® SERIES, INCANDESCENT, STOP/TURN/TAIL | BACK-UP, KIT

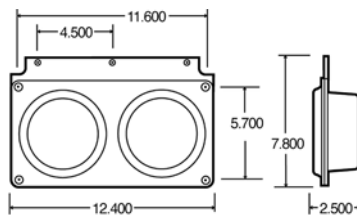

- Features metal mounting flange with high-impact plastic module box
- Optional mounting gasket #97938 available to provide extra seal between module and body



Part Number	Position	Mount/Trim Color	S/T/T Light Part#	B/U Light Part#	Harness	Flange Mount	Housing	Grommet	Volts
40754	LH	Black	40242R	40244	50201	40721	40722	40700	12
40755	RH	Black	40242R	40244	50201	40721	40722	40700	12

MODULE COMPONENTS

Part #	S/T/T Light Part#	B/U Light Part#	Harness	Flange Mount	Housing	Grommet
Part #	40242R	40244	50201	40721	40722	40700
Quantity	1	1	1	1	1	2

Standards Met	Compliance Family
S2 I6 R T	FMVSS 108 CMVSS 108 DOT SAE

INCANDESCENT
40 SERIES

INCANDESCENT
40 SERIES

SIGNAL-STAT, INCANDESCENT, STOP/TURN/TAIL | BACK-UP



- Unique housing offers shock absorbency and allows lamp replacement without tools
- Features rugged thermoplastic rubber housing
- High-impact polypropylene cover
- Pre-wired terminal contact strip included

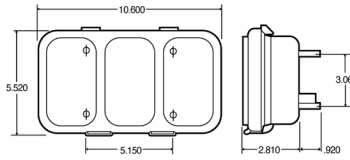

Part Number	Position	Mount/Trim Color	S/T/T Light Part#	B/U Light Part#	Housing	Cover	Volts
45740	LH	Black	45202R	45204	45323	45333	12
45741	RH	Black	45202R	45204	45323	45333	12

MODULE COMPONENTS

	S/T/T Light Part#	B/U Light Part#	Housing	Cover
Part #	45202R	45204	45323	45333
Quantity	2	1	1	1

Standards Met	Compliance Family
P2 S2 I6 R A T	FMVSS 108 CMVSS 108 DOT SAE

SIGNAL-STAT, INCANDESCENT, STOP/TURN/TAIL | BACK-UP | TURN SIGNAL



- Unique housing offers shock absorbency and allows lamp replacement without tools
- Features rugged thermoplastic rubber housing
- High-impact polypropylene cover
- Pre-wired terminal contact strip included

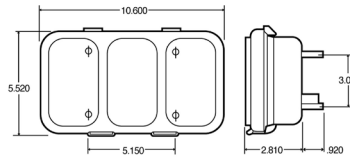

Part Number	Position	Mount/Trim Color	S/T/T Light Part#	B/U Light Part#	Turn Signal Light Part#	Housing	Cover	Volts
45742	LH	Black	45202R	45204	45201Y	45323	45333	12
45743	RH	Black	45202R	45204	45201Y	45323	45333	12

MODULE COMPONENTS

	S/T/T Light Part#	B/U Light Part#	Turn Signal Light Part#	Housing	Cover
Part #	45202R	45204	45201Y	45323	45333
Quantity	1	1	1	1	1

Standards Met	Compliance Family
P2 S2 I6 R A T	FMVSS 108 CMVSS 108 DOT SAE

INCANDESCENT

SIGNAL-STAT

INCANDESCENT

SIGNAL-STAT